

**Wrap Yourself in Comfort and Quiet
Eco-conscious Technologies from Japan**

**Air to Water Catalogue
2024**



Environmental Sustainability Vision 2050

Environmental Declaration

Protect the air, land, and water with our hearts and technologies to sustain a better future for all.



Environmental Sustainability Vision 2050

To solve various factors that lead to environment issues, the Mitsubishi Electric Group shall unite the wishes of each and every person, and strive to create new value for a sustainable future.

Three Environmental Action Guidelines

1

Apply diverse technologies in wide-ranging business areas to solve environmental issues

2

Challenge to develop business innovations for future generations

3

Publicize and share new values and lifestyles

Key Initiatives

- Climate Change Measures
- Resource Circulation
- Live in Harmony with Nature
- Long-term Activities
- Innovation
- Nurturing Human Resources
- Understanding Needs
- Co-create and Disseminate New Values
- Live in Harmony with the Region

Heat pump technology inspires Mitsubishi Electric to design air conditioners that harmonize comfort and ecology.

Heat Pump Principle (When Heating)
<Case of COP 5.0>

Refrigerant and Heat Circulation

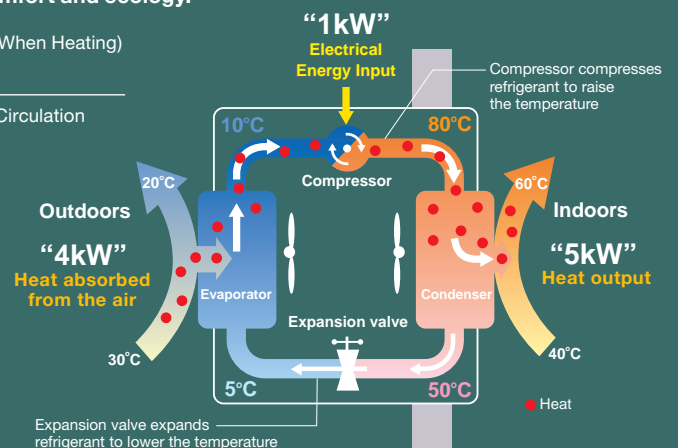



Mitsubishi Electric takes on the challenge of creating new value and contribute to a sustainable future in order to solve various environmental problems.

Preventing Global Warming

Mitsubishi Electric is actively introducing R32 refrigerant which has a global warming potential approximately 1/3 that of R410A refrigerant. Not only by shifting from R410A to R32 but by decreasing the diameter of refrigerant piping, we are also striving to reduce the amount of refrigerant usage. Through these activities, we have achieved significant reduction in CO₂ equivalent amount compared to conventional models and realised minimizing the negative impact to the environment more than ever.

Reducing the amount of refrigerant usage

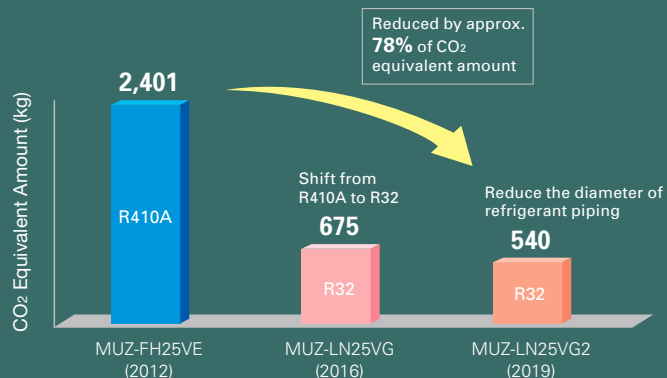

* reduction rate differs model by model.

Effective use of materials (Reduce & Recycle)

1. Accelerating the downsizing technology to reduce material use while balancing energy saving performance.
2. Designing products that are easy to separate and recycle.
3. All models are designed for WEEE and RoHS (II) compliance.*

*WEEE and RoHS directive: The Waste Electrical and Electronic Equipment (WEEE) Directive is a recycling directive for this type of equipment, while the Restrictions of Hazardous Substances (RoHS) Directive is an EU directive restricting the use of ten specified substances in electronic and electrical devices. In the EU, it is no longer possible (from July 2019) to sell products containing any of the ten substances.

Balancing comfort and ecology

Mitsubishi Electric develops technologies to balance comfort and ecology, achieving greater efficiency in heat pump operation.

	Comfort	Ecology
1. Inverter	Faster start-up and more stable indoor temperature than non-inverter units.	Fewer On/Off operations than with non-inverter, saving energy.
2. 3D i-see Sensor	Since the positions of people can be detected, airflow can be set to personal taste, such as in airflow path or protected from the wind. The ability to adjust to individual preferences realizes more comfortable air conditioning.	Since the number of people in a room can be detected, energy-saving operation is adjusted or the power is turned off automatically. Efficient air conditioning with less waste is realized.
3. Flash Injection	Achieves high heating capacity even at low temperatures, plus faster start-up compared to conventional inverters.	Expands heat pump heating system to the cold regions to replace combustion heaters.
4. Dual Barrier Coating Dual Barrier Material	Prevents the indoor unit from getting dirty, delivering you clean air.	Keeping the inside of air conditioner clean leads to efficient operation and energy saving.

C

ONTENTS



LINE-UP & FEATURES 005-028

ECODAN MULTI 029-038

SPECIFICATION 039-056

REFRIGERANT AMOUNT 057

AIR TO WATER



SELECTION

Choose the series that best matches the building layout.

Excellent ecodan's heating performance, even at low outdoor temperature!

R32

D-GEN INDOOR UNIT

Hydrobox, Cylinder unit



OUTDOOR UNIT

Packaged type	Small capacity (Under 5kW)*	Medium capacity (6kW-14kW)*
		 PUZ-HWM140
	 PUZ-WM50	 PUZ-WM85/112
Split type	Small capacity (Under 5kW)*	Medium capacity (6kW-14kW)*
		 PUD-SHWM80/100/120/140
		 PUD-SWM80/100/120
Eco Inverter	 SUZ-SWM40VA2 SUZ-SHWM40VAH	 SUZ-SWM60VA2 SUZ-SWM80VA(H)2/SUZ-SWM100VA(H) SUZ-SHWM60VAH

*Rated capacity is at conditions A2W35. (according to EN14511)





R32

E-GEN INDOOR UNIT

Hydrobox, Cylinder unit



OUTDOOR UNIT

Split type	Medium capacity (6kW-14kW)*
	 PUD-SHWM80/100/120/140
	 PUZ-SWM80/100/120/140

*Rated capacity is at conditions A2W35. (according to EN14511)

R410A

D-GEN INDOOR UNIT



Hydrobox, Cylinder unit



OUTDOOR UNIT

Split type	Large capacity (≥16kW)*
	 PUAZ-SHW230
	 PUAZ-SW160/200

*Rated capacity is at conditions A2W35. (according to EN14511)

Other ATW-related system	PUMY + ecodan	PXZ + ecodan
	<p>R410A</p>  PUMY-P112/125/140	<p>R32</p>  PXZ-4F75VG  PXZ-5F85VG

New Eco-design Directive

What is the ErP Directive?

The Eco-design Directive for Energy-related Products (ErP Directive) established a framework to set mandatory standards for ErPs sold in the European Union (EU). The ErP Directive introduces new energy efficiency ratings across various product categories. It affects how products such as computers, vacuum cleaners, boilers and even windows are classified in terms of environmental performance. Labelling regulations that apply to our ATW heat pumps came into effect from September 26, 2015, and then revised from September 26, 2019.

New energy label and measurements

Under directive 2009/125/EC, ATW heat pumps of up to 70kW are required to show their heating efficiency on the energy label. The purpose of the energy label is to inform customers about the energy efficiency of a heating unit. The efficiency for space heating is ranked from A+++ to D (from September 2019). In the case of domestic hot water, it is from A+ to F (from September 2019).

Product label

This label is for individual heating units, such as an ecodan heat pump. Typically, the space heater label is used for ecodan systems with a hydro box, and the combination heater label is used for ecodan systems with a cylinder unit.

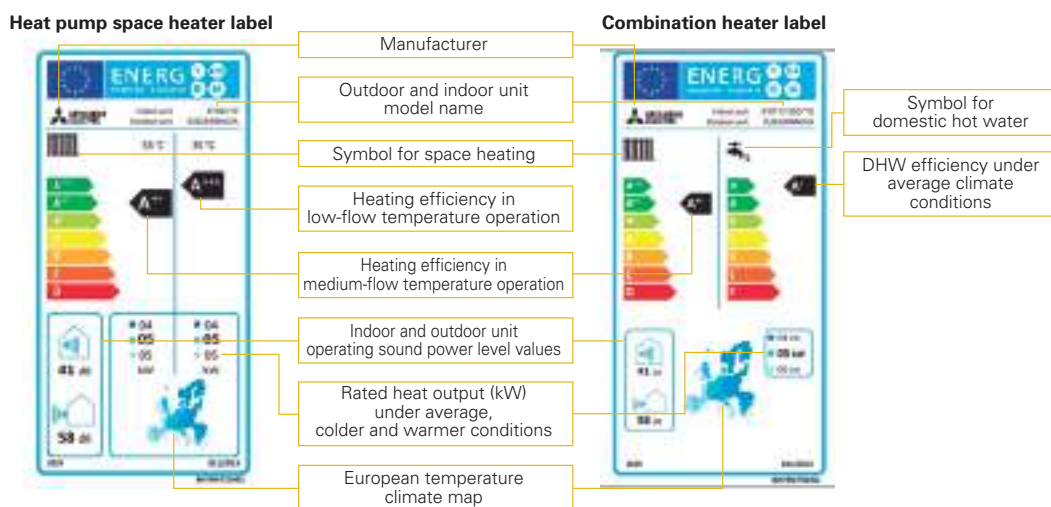

These labels are delivered with all ecodan outdoor units.

What is the package label?

A heating system can use several energy-related products, such as a controller or solar thermal system. Therefore, a label showing the efficiency of the total heating system is required. The category range is defined from A+++ to G.

Creating the package label is the responsibility of the installers and distributors. A useful tool on the Mitsubishi Electric website is available to easily create the labels for ecodan products and controllers.

<http://erp.mitsubishielectric.eu/erp/options>

Package label

This label is for heating systems that use several energy-related products, such as a controller or a solar thermal system.

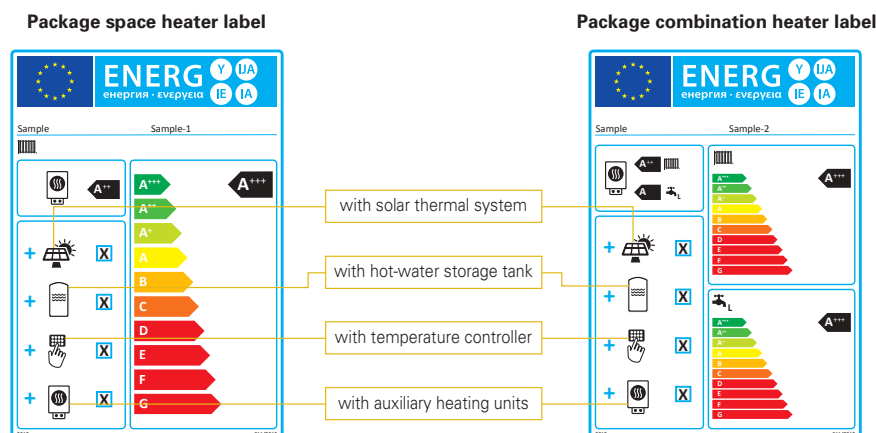

Customised package labels including ecodan heat pumps and the FTC6 controller can be created on the Mitsubishi Electric website.

R32 Eco Inverter Line-up

Wider line-up

Standard/Hyper heating/Standard with base heater models are available.

SUZ Series		4kW	6kW	8kW	10kW
Previous	Standard SUZ-SWM	✓	✓	✓	—
	Standard SUZ-SWM	✓	✓	✓	✓
New	Hyper Heating* with base heater SUZ-SHWM	✓	✓	—	—
	Standard with base heater SUZ-SWM	—	—	✓	✓

*Hyper Heating model: Keep 100% heating capacity at -15°C.



Standard
SUZ-SWM40/60VA(2)
Hyper Heating with base heater
SUZ-SHWM40VAH

Standard
SUZ-SWM80/100VA(2)
Hyper Heating with base heater
SUZ-SHWM60VAH
Standard with base heater
SUZ-SWM80/100VAH(2)

Performance Guaranteed Range Expansion for Max Outlet Water Temperature

New SUZ achieved to keep max outlet water temperature of 60°C in ambient -3°C. Especially Standard 80/100, Hyper Heating 60, and Standard with base heater 80/100 models can also keep max outlet water temperature of 55°C in ambient -15°C.

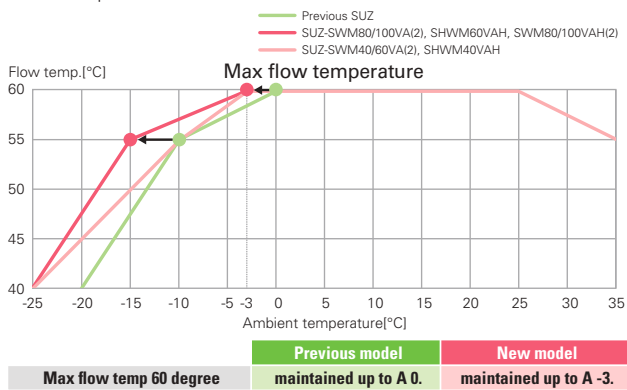

Performance Guaranteed Range Expansion

Performance guaranteed range is extended to -25°C.

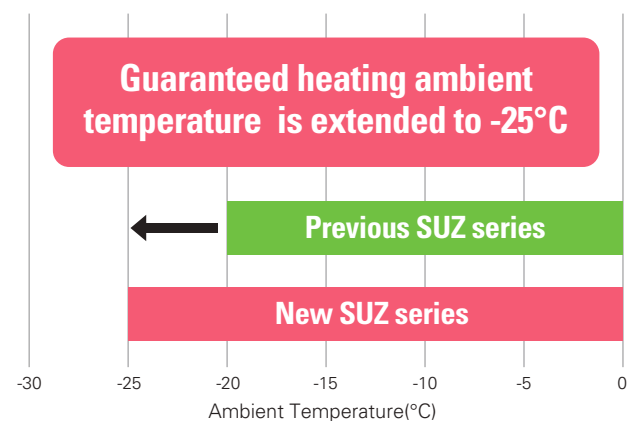

Quiet mode

Once Quiet mode is activated using the remote controller, SUZ's sound volume becomes lower than normal mode. There are 2 Quiet mode levels in SUZ.

*Outdoor condition is A-7W35.

*The cooling and heating capacity may drop if this function is activated.

*Sound power level values are based on EN12102.

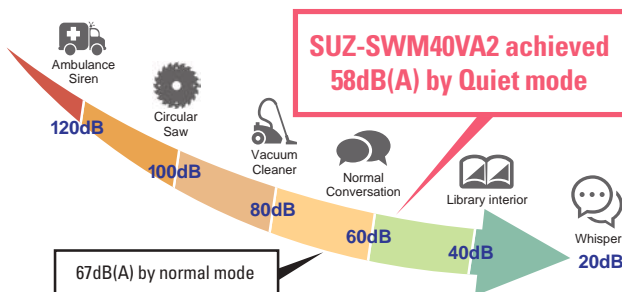

Improved flexibility for installation

The minimum piping length is reduced to 2m, and the maximum piping length is extended to 46m for SUZ-SWM80/100VA(2), SHWM60VAH, SWM80/100VAH(2)

This enables for flexible installation in any wider properties.

	40	60	80	100
Standard [m]	2-26*	2-26*	2-46*	2-46*
Hyper Heating with base heater [m]	2-26*	2-46*	-	-
Standard with base heater [m]	-	-	2-46*	2-46*

* For lengths exceeding this, please contact the sales network.

Blue fin

A special coating is applied to the heat exchanger to improve corrosion toughness.

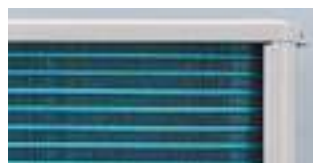

New PUZ Series

Great Line-up for Heating and Cooling

Our new flagship PUZ series offers optimized heating and cooling performance and covers both ranges, POWER INVERTER and ZUBADAN.

In addition to space heating and hot water supply, new PUZ series can easily combine with fan coils or underfloor cooling systems to provide with the best thermal comfort also in summer.



Refrigerant	Operation	Series	Power supply	80	100	120	140
R32	Reversible	POWER INVERTER	1Φ230V	●	●	●	●
			3Φ400V	●	●	●	●
		ZUBADAN	1Φ230V	●	●	●	●
			3Φ400V	●	●	●	●

Further Enhanced Energy Efficiency

ErP Lot 1 Compliant with Highest Seasonal Space Heating Energy Efficiency Class A+++

All models have achieved the "RANK A+++" for SCOP with average climate at low temperature. Thanks to further design optimization, new PUZ is achieving better performance and contributing to reduce energy consumption in a wide range.

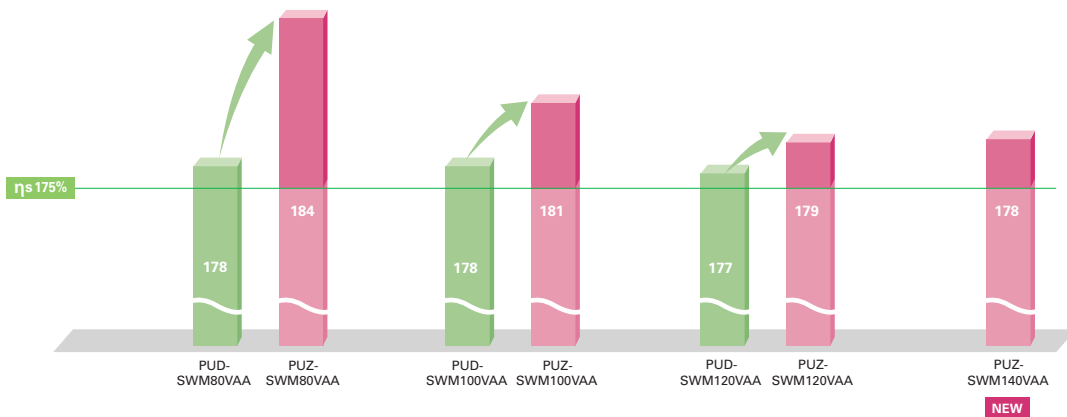

High Performance

Guaranteed Heating Operation Range is Extended to -30°C Ambient Temperature

Mitsubishi Electric's unique technology and compressors allow the heat pump to achieve the wider guaranteed heating operation range. 70°C max flow temperature can be maintained down to ambient -7°C for PUZ-SHWM. Even at ambient -30°C, the flow temperature can be kept at 50°C. *

*When ΔT is 10°C and the piping length is 15m or less. *E-generation connection

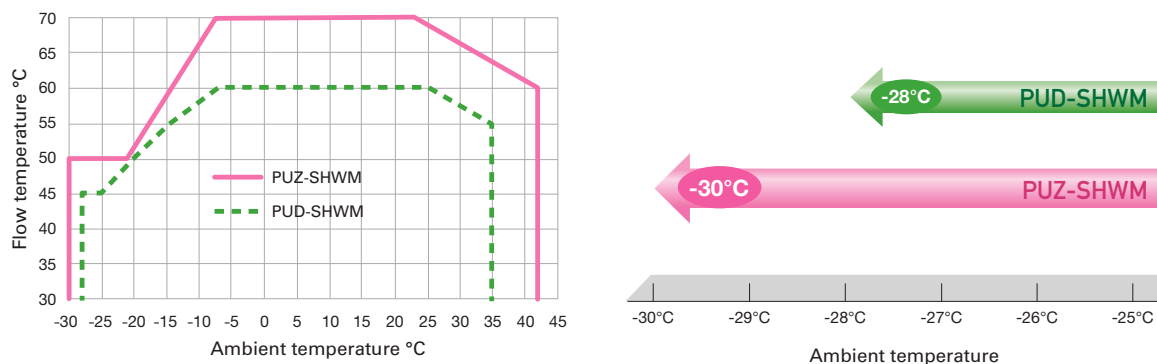

Quiet Performance

Improved noise reduction

PUZ achieves quieter operation than previous model with its double anti-vibration structure.

- New 80 models achieved 54dB(A) in PWL.
- New 100-140 models achieved 58dB(A) inPWL.

*Sound power level values are based on EN12102.

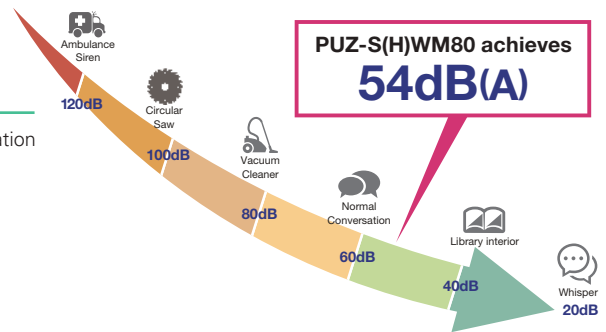

Quiet mode

Three-stage quiet mode enables low-noise operation that can be adjusted to meet severe noise conditions.

*The cooling and heating capacity may drop when Quiet mode is activated.

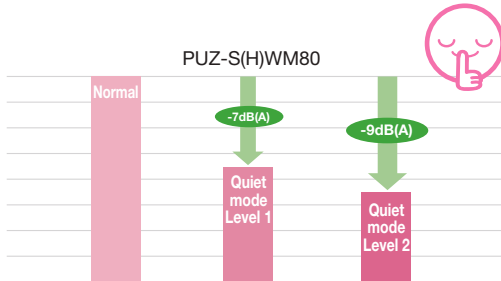

Double anti-vibration structure

This double structure of an anti-vibration plate and foot rubbers reduces vibration noise to provide high quality performance while minimizing noise.

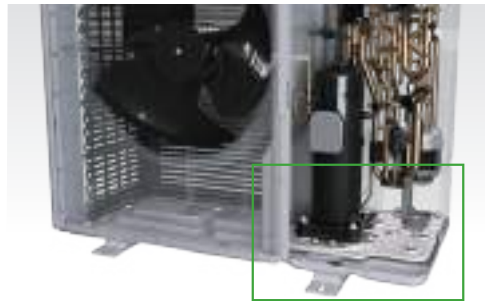

The rate of vibration transmission is greatly reduced by installing stat bolts and foot rubbers on the base and placing an anti-vibration plate on top of it.

In addition, three layers of felt around the compressor absorbs noise. With these unique sound insulation structures, the unit enables less restrictions in residential areas.

Installation

Piping length

Max piping length can achieve up to 50m* for more flexible installation.

Refrigerant amount

The necessary refrigerant amount has been reduced to 2,4kg at maximum, that's why the installation restrictions are limited.

No additional refrigerant charge (1.8kg) ➡ No indoor unit installation restrictions.

1.8~2.4kg of refrigerant ➡ Additional refrigerant charge allows up to 50m* piping length.

*For heating/cooling operation with PUZ-S(H)WM120/140, the max piping length is 30m.

Piping length and refrigerant charge amount

New PUZ achieves maximum 50m pipe length. This enables for flexible installation in any wider properties. To keep the maximum amount of refrigerant below 2.4 kg, the upper limit differs depending on heating only and reversible.

	Piping length	Initial amount	Refrigerant amount(kg)	2~3m	~5m	~10m	~15m	~20m	~25m	~30m	~35m	~40m	~45m	~50m			
				Total										2	2.1	2.2	
Heating only operation	PUZ-S(H)WM 80/100AA	2~50m	1.8kg	1.8										2	2.1	2.2	
				Additional charge										No additional charge			+0.20
	PUZ-S(H)WM 120/140AA	2~50m	1.8kg	1.8										2	2.2	2.3	2.4
				Additional charge										No additional charge			+0.20
Heating/Cooling operation	PUZ-S(H)WM 80/100AA	2~50m	1.8kg	1.8			1.9	2	2.1	2.2	2.3	2.4					
				Additional charge			No additional charge			+0.10	+0.20	+0.30	+0.40	+0.50	+0.60		
	PUZ-S(H)WM 120/140AA	2~30m	1.8kg	2.2		2.3		2.4									
				Additional charge		+0.40	+0.50	+0.60									

D generation Indoor Unit

All-in-one Compact Indoor Unit

- All-in-one: Key functional components are incorporated
- Compact cylinder unit: 1,400~2,050mm in height
- Compact hydro box: Only 530x360mm footprint
- Easy installation: Factory fitted pressure relief valve
- Easy service: Relevant parts are located at the front of the unit for easy maintenance
- Easy transport: Handles attached on front and back (cylinder unit)

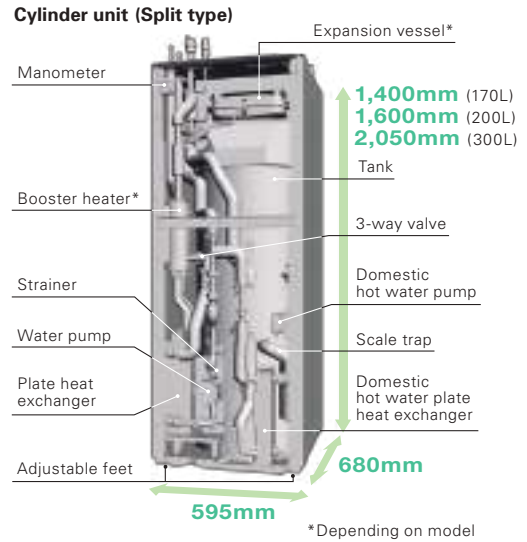
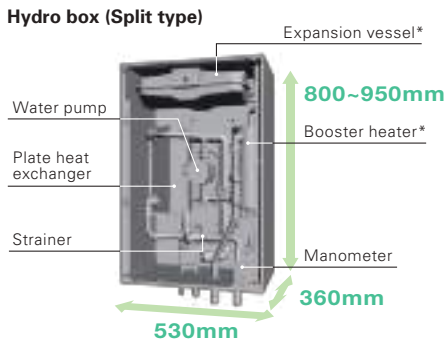

*Depending on model

Line-up

ecodan's line-up has many types of indoor units to satisfy diverse customers' needs, requests and local regulations. It includes various capacity units, with/without booster heater, with/without an expansion vessel, etc. In addition, a reversible hydro box and a reversible cylinder unit are available.

Hydro box



Cylinder unit



Available options

- Packaged or Split type
- With/without booster heater
- With/without expansion vessel
- Cylinder unit has an integrated 170L/200L/300L stainless steel tank
- Hydro box is control ready for domestic hot water with a stand-alone tank (locally supplied)

Reversible Models (for heating/cooling)

Perfect Comfort in Winter and Summer Time, Thanks to Our Reversible Models.

Reversible models are now available for both hydro box and cylinder units (Both for split type and cylinder unit for packaged type). The new reversible cylinder is now able to produce cold water for cooling use and can alternatively produce domestic hot water in summer time.

Reversible hydro box



Reversible cylinder unit



Remote Controllers D generation

Smart User-friendly Controller with Stylish Design

Main remote controller

- Large screen and backlight for excellent visibility, even in dark environment
- Multi-language support (supports 15 languages)
- Can be removed from main unit and installed in a remote location (up to 500m)
- Quick reading of operation data (7.5 times faster than previous model)
- Wide range of convenient functions in response to user demand

Function settings

- Energy monitoring
- Two-zone control (cooling and heating)
- Two separate schedules
- Summer time setting
- Built-in room temperature sensors
- Hybrid control (boiler interlock)
- Floor drying mode
- Weekly timer
- Holiday mode
- Legionella prevention
- Error codes



Main controller



PAR-WR51R-E (Option) Receiver



PAR-WT50R-E (Option) Wireless remote controller

Wireless remote controller (optional)

- Built-in room temperature sensor; easy to place in the best position to detect room temperature
- Wiring work eliminated
- Simple design that is easy to operate
- Remote control from any room without needing to choose an installation location
- Backlight and big buttons that are easy to operate
- Domestic hot water boost and cancellation
- Simplified holiday mode



*SD logo is a trademark of SD-3C, LLC

Energy Monitoring

View Electricity Consumption and Heat Output on the Remote Controller

Every end user can now easily check the energy data of the ecodan heat pump.

Other features

- Daily, monthly and yearly data are stored and can be displayed using the main remote controller.
- External power meter and heat meter can be connected for accurate measurement.
- SD card is also available for storing data.

*Using pre-set values on the main remote controller, estimated energy consumption/output can be shown without external power and a heat meter.

Depending on operating condition and system configuration, there is some possibility to show different data from the reality.

*This function is available depending on the version of the outdoor unit model.

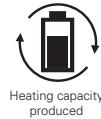

Heating capacity produced



Electric energy used

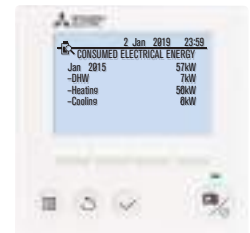

*SD logo is a trademark of SD-3C, LLC

Summer Time Setting

Easy Adjustment for Summer Time

Just switch the summer time mode 'on' using the main remote controller and the clock in the main remote controller is adjusted to summer time hours.

This function can release the end user from clock setting tasks.

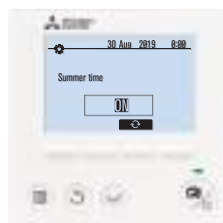

Two Separate Schedules

Pre-setting Two Different Schedules for Winter and Summer Seasons

Two different schedule settings are available for use via the main remote controller.

These schedules can be pre-set and changed depending on the season. For example, from November to March, space heating and domestic hot water are used; however, during warm months such as from April to October, only domestic hot water is used.

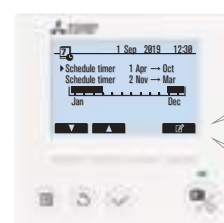

<Example>

Schedule 1	Winter time
Space heating	daytime
Domestic hot water	early morning
Schedule 2	Summer time
Domestic hot water	any time

Easy Commissioning

Pump for Primary Water Circuit* Speed Setting Possible Using ecodan's Main Remote Controller

Even when the system is running, pump output can be set to one of five different settings using the main remote controller.

The person commissioning the system can adjust this speed much more easily.

*Speed setting of pump for domestic hot water is not available through the main remote controller when the system is running.

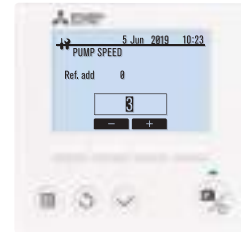

Flow sensor newly incorporated

The flow sensor is key for monitoring energy output and can also be used to detect flow error as well.

- Flow rate can be checked on the main remote controller.
- Flow rate can also be shown as graphs using the SD card tool.



Run indoor unit* without outdoor unit

During installation or situations such as an outdoor unit malfunction, the indoor unit can be operated using a heater.

While using this mode, flow and tank temperature are selectable.

Fixing and maintenance of the outdoor unit can be done without stopping heating and domestic hot water operation*.

*Models with electric heater only.

*When the indoor unit operation stops, please check all settings after the outdoor unit is connected.



*SD logo is a trademark of SD-3C, LLC

SD* Card

For Easier Settings and Data Logging

The initial setting for ecodan is now simpler than ever before. The special software enables the required initial settings to be saved to an SD card using a personal computer. The system set-up is as easy as moving the SD card from the computer to the SD card slot in the indoor unit. Compared to the previous procedure of inputting settings using the main controller at the installation site, a remarkable reduction in set-up time has been achieved. Thus, it is ideal for busy installers.

*SD card function is only used at the time of installation.

Hydro box operation panel

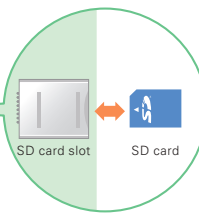
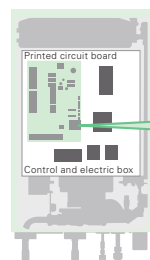

Settings can be performed easily and the logging of operation data saved to an SD card can be confirmed via a personal computer.



Items that can be pre-set

Simply copying pre-set data to an SD card, the same settings can input into another unit using the SD card.

- Initial settings (time display, contact number, etc.)
- Heating settings
 - Auto adaptation
 - Heat curve
 - Two different temperature zones (heating and cooling)
- Interlocked boiler operation settings
- Holiday mode settings
- Schedule timer settings (two separate schedules)
- Domestic hot water settings
- Legionella prevention settings

All items that are set by the main controller can be set via a personal computer.

Data that can be stored

Operation data up to a month long can be stored on a single SD card

- Consumed electrical energy
- Delivered energy
- Flow rate
- Operation time
- Defrost time
- Actual temperature
 - Room temperature
 - Flow temperature
 - Return temperature
 - Domestic hot water temperature
 - Outdoor temperature
- Error record
- Input signal
- Etc.

E generation Indoor Unit

Line-up

ecodan's line-up has many types of indoor units to satisfy diverse customers' needs, requests and local regulations. It includes various size of tank up to 300L, with/without booster heater, with/without an expansion vessel, etc. In addition, reversible hydrobox and cylinder units are available.

Hydrobox Cylinder unit



New Design

ecodan E generation is now available in a new design. This simpler and more sophisticated new logo unit blends in nicely with any interior design.

Available Indoor Units

- Packaged or Split type
- Reversible (for heating/cooling) or Heating only model
- With/without booster heater
- With/without expansion vessel
- Cylinder unit has an integrated 170L/200L/300L stainless steel tank
- Hydrobox allows control for domestic hot water with a stand-alone tank (locally supplied)

All-in-one Compact Indoor Unit

- All-in-one: Key functional components are incorporated
- Compact cylinder unit: 1,400~2,050mm in height
- Compact hydrobox: Only 530x360mm footprint
- Easy installation: Factory fitted pressure relief valve
- Easy service: Relevant parts are located at the front of the unit for easy maintenance
- Easy transport: Handles attached on front and back (cylinder unit)

NEW "New" means that these features are only available on the E generation units; all other features are present on both the D and E generation units.

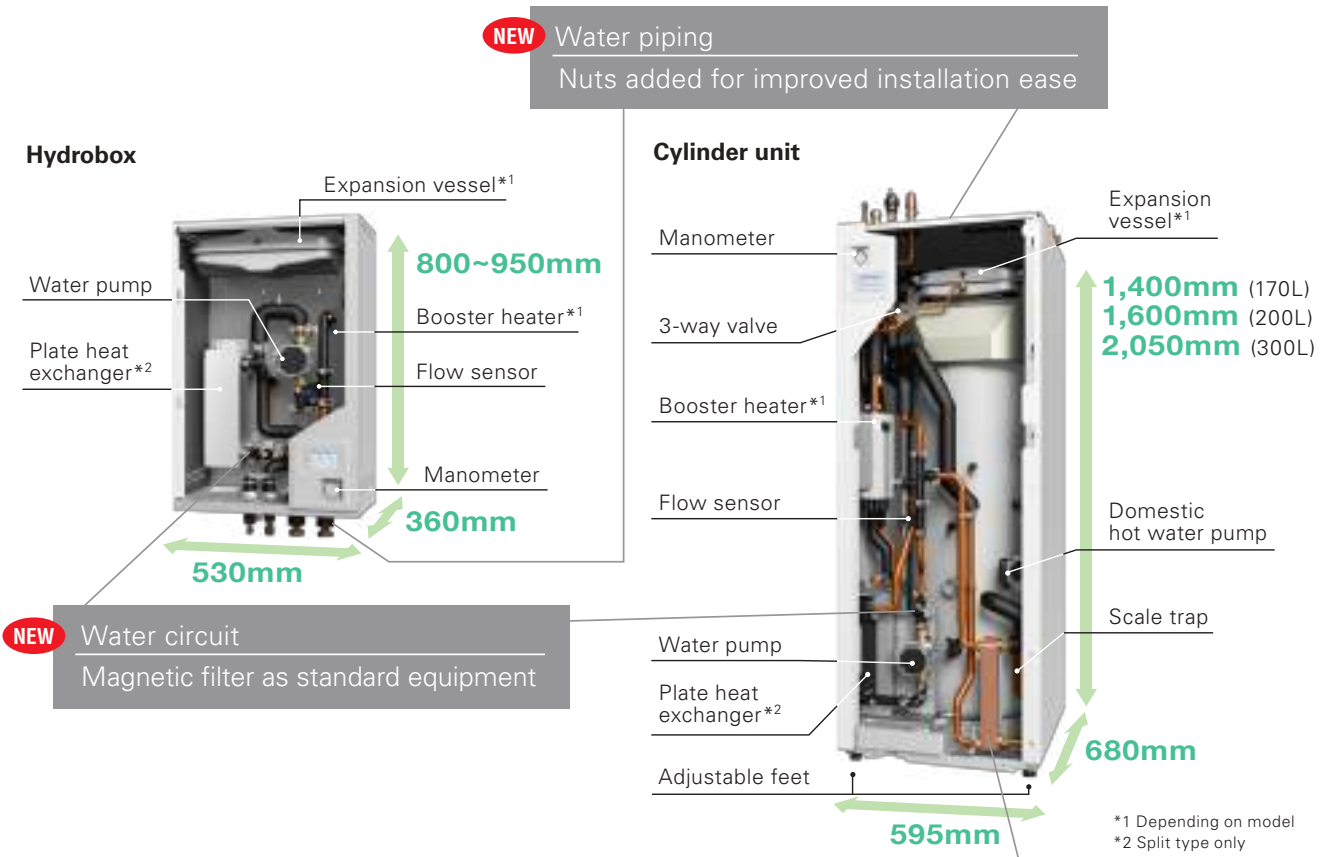

Domestic hot water plate heat exchanger

High efficiency plate heat exchanger offers better performance and allows to use the whole tank volume for DHW compared to coil in tank.

Easy Installation and Low Maintenance

Simple Piping Arrangement NEW

All water piping is aligned at the rear side of the unit for easy connection and neat finish. In addition, NUTs are added to improve ease of installation.



Built-in Drain Pan for Reversible Cylinder Models

Reversible models include a built-in space saving drain pan and the drain socket is positioned at the back of the unit. With use of the adjuster bolt, the outlet height can be higher than 50mm, allowing 5m drainage.



Hydrobox Piping Arrangement

Through structural innovation related to the space around the pipes, the area where the spanner can be moved has been increased, thus improving pipe work and enabling it to be completed smoothly.

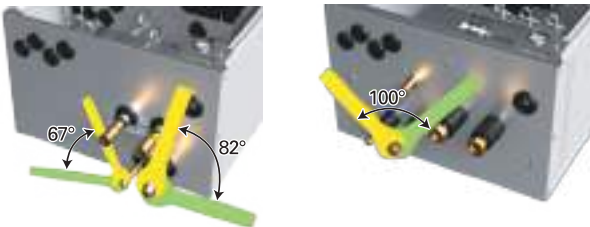

Easy Adjustment

Adjust bolt capable of 50mm expansion for easy installation on uneven surfaces.



Improved Quick Start NEW

To start ecodan quickly, initial settings are narrowed down to the essential items and unnecessary settings are skipped automatically. Displaying the system configuration before commissioning helps clarify the basic Dip switch position and prevent resetting. This reduces time needed to complete commissioning.

Sample display of Emitter setting



Installers can simply select emitters and use the recommended default values, preventing wrong running mode per zone.

Operation Data Monitoring

Time, operation mode, flow/return/tank temperature, can be displayed on main remote controller.

Sample display of monitoring setting

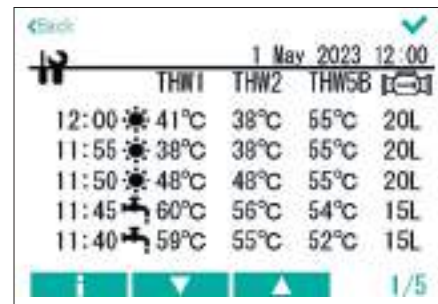

Minimum Additional Water Required

In average/warmer conditions, minimum additional water is required for outdoor unit. If there is enough water amount inside water pipe, radiator, or underfloor heating, no buffer tank is required.

*Refer to the indoor unit installation manual for specific outdoor unit models.

Clean Circuit Water NEW

Magnetic filter is newly added into the strainer. This keeps the water in the circuit clean and prevents clogging and deterioration of pumps and 3 way valves.

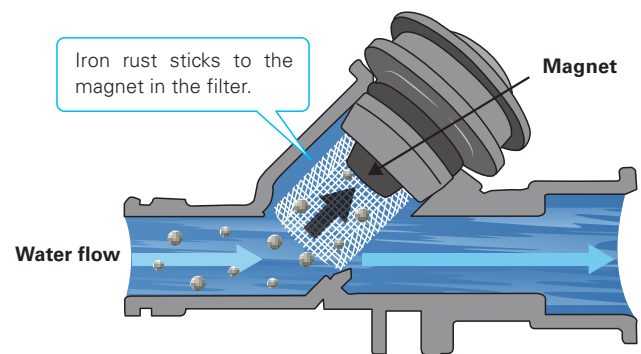

High Performance

High Efficiency

With additional thermistor (THW5A), η_{wh} [%] rating is improved 170L and 200L to achieve A+, the highest possible domestic hot water efficiency rank.

Excellent DHW efficiency



	170L	200L	300L
Declared load profile	L	L	XL
Water heating energy efficiency class	A+	A+	A/A+

Thermistor Position of Cylinder

The thermistor position is selectable allowing the unit to accommodate for different water demands in order to maximise the efficiency of the unit for any size of household or application. Using two thermistors equipped with all sizes of tanks, you can now select the DHW recharge amount from two options (Standard/Large). It helps to accommodate for different water demands in order to maximise the efficiency of the unit for any size of household or application. This mode can be selected from main remote controller.

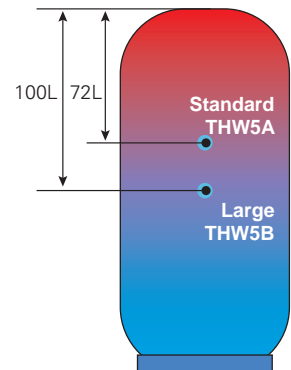

* In case of 200L tank.

Unique Technology of ecodan

2 Zone Control (for heating/cooling) by Local Supplied Components

Improved Simultaneous Control of Two Different Zones



*microSD logo is a trademark of SD-3C, LLC.

Using ecodan, it is possible to control two different flow temperatures, thereby managing two different heating load requirements. Now, by adding a new mixing control in zone 1 as well as zone 2, the flow temperature can be controlled in both zones, providing more flexible heating operation anywhere in the house. The system can adjust and maintain two flow temperatures when different temperatures are required for different rooms; for example, controlling a flow temperature of 40°C for the bedroom radiators and another flow temperature of 30°C for the living room floor heating. Also, new controller monitors the temperature inside buffer tank and prioritizes using the heat inside the tank to avoid frequent on/off operation when using 2 zone control. This function allows better integration with smart grid or energy management system because the buffer tank can be heated up independently from the zones temperature requests (even for zone 1).

Two temperature zones

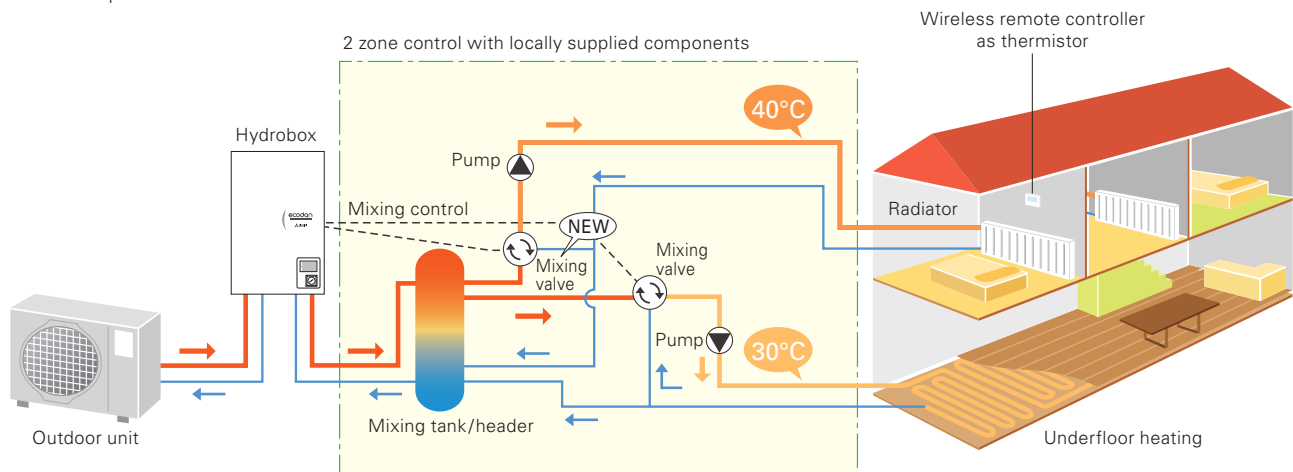

* Items such as a mixing tank, mixing valves and pumps are not included and need to be purchased locally.

2 Zone Kit (Optional)

- You can select from 3 types of pump operations, 1. Fixed speed mode, 2. Fixed pressure mode, 3. Energy saving mode, depending on your preference.
- All-in-one kit: Key functional components are incorporated in 2 zone kit.
- Easy installation: G1 screw type flexi-piping to avoid brazing.
- Compact size: Just to fit on the top of cylinder unit, also wall mountable.





*microSD logo is a trademark of SD-3C, LLC.

Auto Adaptation for Heating

Maximise Energy Savings While Retaining Comfort at All Times

Regarding the relation of flow temperature and unit performance, a drop in the flow temperature improves the coefficient of performance (COP) of the ATW system. This means that energy savings are dramatically affected by controlling the flow temperature in the system.

Weather compensation curve setting (Example)

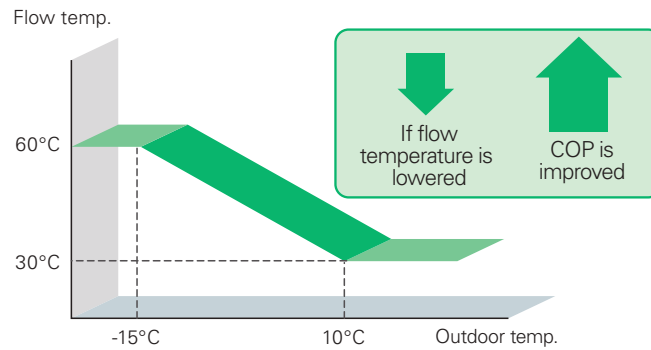

Automatically Tracks Changes in the Actual Room Temperature and Outdoor Temperature to Adjust flow Temperature Accordingly

Aiming to realise further comfort and energy savings, Mitsubishi Electric has already introduced a revolutionary controller. Auto Adaptation function measures the room temperature and outdoor temperature, and then calculates the required heating capacity for the room. Simply stated, the flow temperature is automatically controlled according to the required heating capacity, while optimal room temperature is maintained at all times, ensuring the appropriate heating capacity and preventing energy from being wasted.

Furthermore, by estimating future changes in room temperature, the system works to prevent unnecessary increases and decreases in the flow temperature. Accordingly, Auto Adaptation maximises both comfort and energy savings without the need for complicated settings.

By introducing improved control logic in our ecodan, we achieved faster heating and more energy saving.

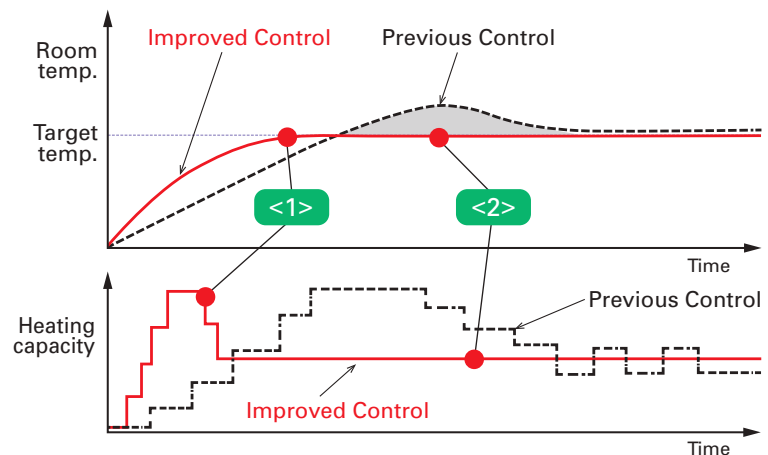

<1> Fast heating with improved accuracy by learning building heat load
 <2> Energy saving by avoiding over heating and capacity fluctuation with better control response, i.e. control interval and resolution

Auto Adaptation Improvement NEW

Mitsubishi Electric's New Auto Adaptation Function Provides Temperature Adjustment that Reflects User Preferences

New Auto Adaptation added manual settings for target temperature compensation based on the building's structure, allowing temperature adjustment according to preferences from Auto/Normal/Slow/Quick. For example, selecting Quick mode allows you to quickly reach the target temperature, thus your room can get warm more quickly. Once the target temperature is reached, the heating capacity is maintained at a constant level, providing energy efficient heating operation. However, in well-insulated houses with underfloor heating emitters, normal or slow mode would be preferred to optimise energy savings and avoid temperature overshoot.

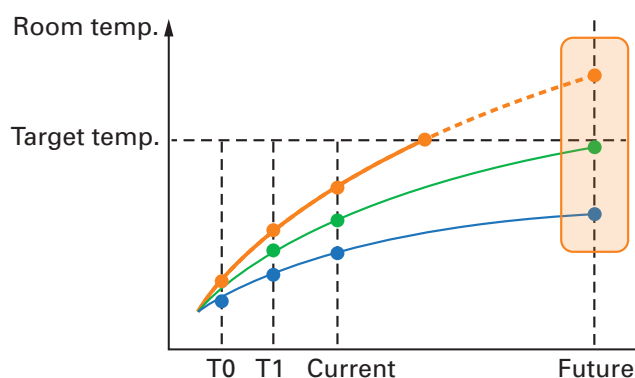

The room temperature at "Future" would be...

*Without considering the flow temperature control after the target temperature is reached.

(Quick) **Higher than the target room temp.**

▶ The control works to lower the flow temp. by comparing the actual and estimated room temperature.

(Normal) **Approximately same as the target room temp.**

▶ The control works to keep the flow temp. by comparing the actual and estimated room temperature.

(Slow) **Lower than the target room temp.**

▶ The control works to raise the flow temp. by comparing the actual and estimated room temperature.

Cooling Functions NEW

Flexible Cooling Control Functions to Suit User's Lifestyle

Weather compensation curve for cooling

Weather compensation curve for cooling is now available. The target water temperature is determined according to changes in ambient temperature. The new user-controlled cooling curve compensation prevents the heat pump from producing excessive flow temperatures for the primary circuit, maximizing efficiency and reducing running costs. FTC uses information from both an outdoor temperature sensor and a temperature sensor on the primary circuit supply to ensure the heat pump is not producing excessive flow temperatures if the weather conditions do not require it.

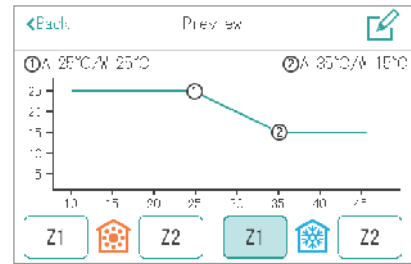

Auto Change Over (ACO)

Instead of the current manual summer/winter mode adjustment, which determines whether heating operation is permitted (or prohibited) according to the ambient temperature, new Auto Change Over is equipped to automatically switch between heating mode and cooling mode according to the ambient temperature. When the ambient temperature reaches a certain level, the operation automatically switches from heating to cooling or cooling to heating. So, there is no need for manual adjustment, providing more comfortable and stress-free room temperature control.

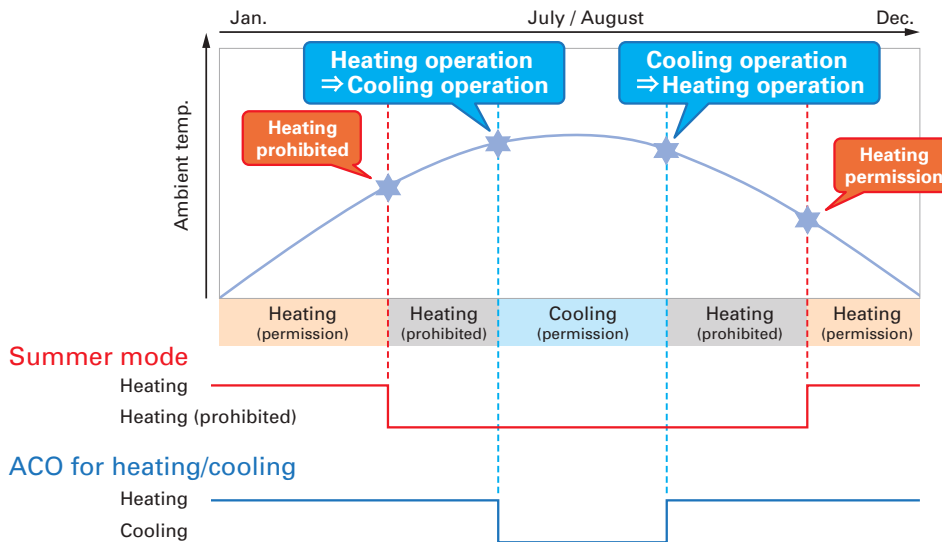

Forced cooling mode

It is now possible to switch to forced cooling mode with an external input. When input terminal IN13 receives a "cooling operation ON" signal from the external source, the operation mode is forcibly switched to cooling. Auto change over judgment is paused during this time. Local supply or your current thermostat can be used to enable cooling ON/OFF.



Cooling lower limit temperature

A new function is available to prevent dew point condensation by forcibly switching the lower temperature limit with an external input. If the water temperature falls below the set value during cooling operation, dew point condensation may occur. Humidity is monitored by a dew point temperature sensor (locally supplied), and when input terminal IN15 receives a signal, the water temperature safety device is activated and the lower limit of the flow temperature is automatically changed. For example, if an external input is received from the sensor when operating at 5°C water flow temperature, the temperature is switched to the lower limit of 20°C, preventing condensation. Cooling target temperature (lower limit) can be set by yourself on remote controller setting screen.

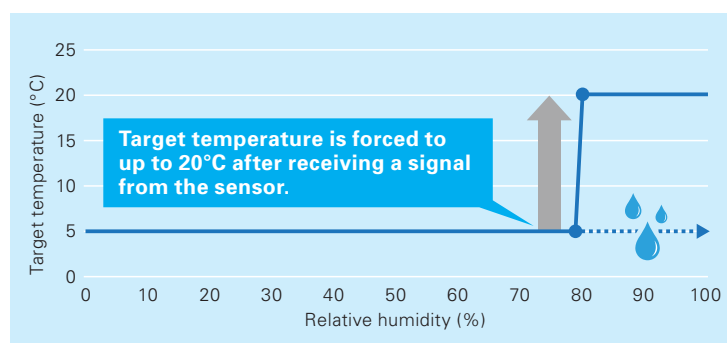

Multiple Unit Control

Connect up to 6 Units – Automatic Control of Multiple Units for Bigger Capacity and Better Efficiency

A maximum of 6 units* can be configured according to the heating/cooling load of the building. The most efficient number of operating units is determined automatically based on heating/cooling load. This enables ecodan to provide optimal room temperature control, and thus superior comfort for room occupants. Also incorporated is a rotation function that enables each unit to run for an equal time period. If one of the units malfunctions when using the Multiple Unit Control, another unit can be automatically operated for back-up, thereby preventing the system operation from stopping completely.

*Only same models (same capacity) can be used.

Multiple unit control

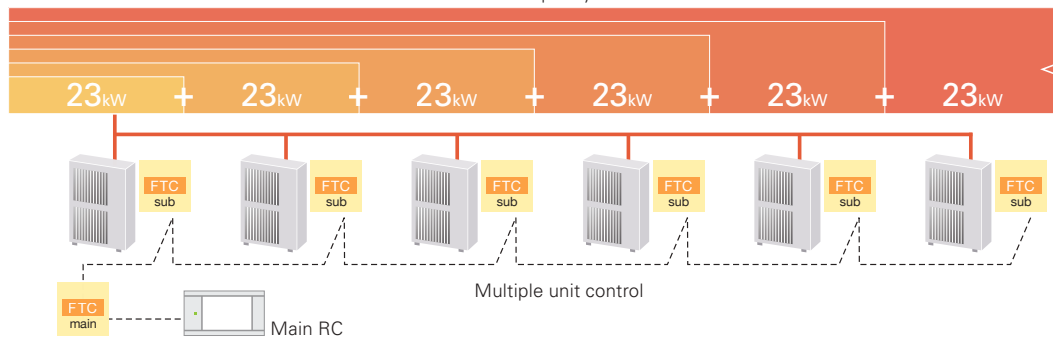
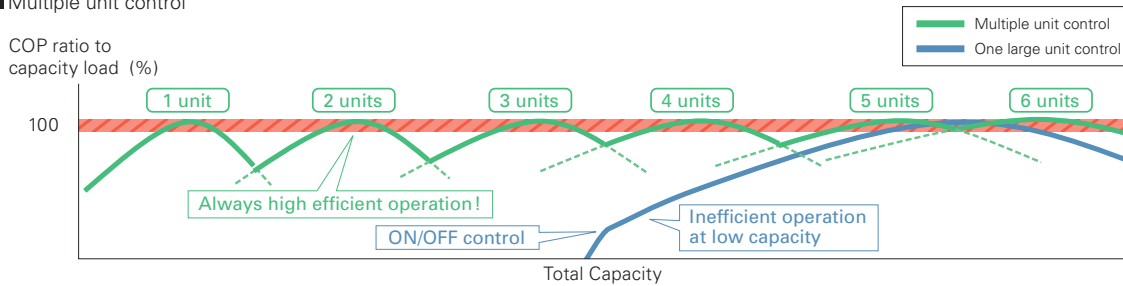

Up to 138kW!!



*microSD logo is a trademark of SD-3C, LLC.

Intelligent Hybrid Control (boiler interlock)

An Existing Boiler Can Be Used for Extra Heating Capacity in an Efficient Way

The flexibility of ecodan's intelligent control allows the system to be combined with the boiler currently in use. Additionally, this control can judge which heating source to use either ecodan or the existing boiler, based on various conditions*.

In the event of one heating unit not working due to some unforeseen problem, the other heating system can be used as a back-up, thereby preventing the heating system operation from stopping completely.

*Please see below "Heat source switchover".

Intelligent system combining a boiler with ecodan

Intelligent boiler interlock system

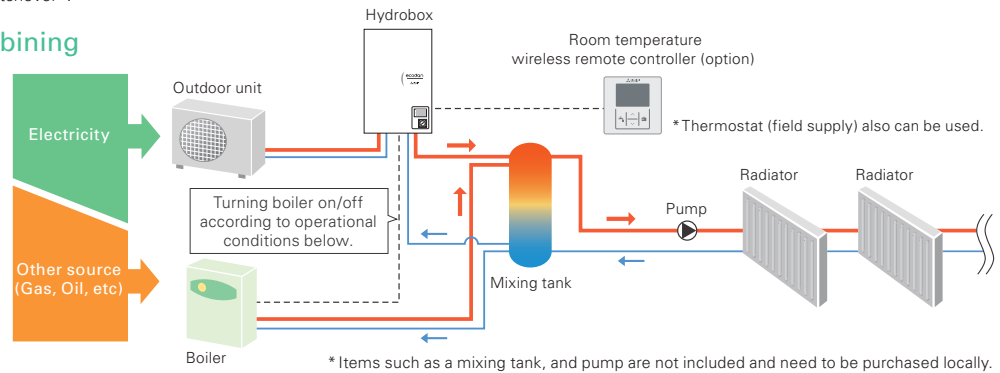

Heat source switchover - Choose appropriate system based on needs

4 types of heat source switchover logic

- ① Switchover based on actual outdoor temperature
 - Heat source switchover occurs when the outdoor temperature drops below a pre-set temperature.
- ② Switchover based on running cost
 - Heat source switchover occurs by judging optimal operation based on running cost.
 - *Pre-registration of the energy price of electricity, and gas or oil per 1kWh is necessary.
- ③ Switchover based on CO₂ emission level
 - Heat source switchover occurs to minimise CO₂ emission.
 - *Pre-registration of CO₂ emission amount from electricity and gas or oil is necessary.
- ④ Switchover can also be activated via external input
 - For example, the peak cut signal from electric power company.

Smart Grid (SG) Ready Function

In recent years, renewable energy generation has become popular. However, this rapid growing causes the problem of supply and demand gap of electricity. The aim of "SG Ready" is to make the electricity demand response more flexible by creating a uniform interface for the smart grid integration of heat pumps. Air-to-Water units need to be able to change the operation pattern when the signal is received from the Smart Grid Controller.

ecodan Cylinder, Hydrobox and FTC (Flow Temperature Control) have been modified to communicate with Smart Grid Controller.

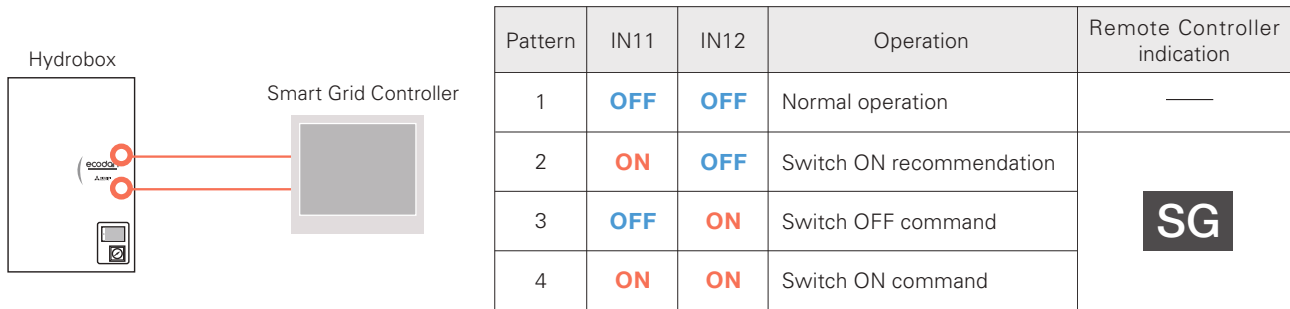

Pattern 1: Normal operation

When there is no signal from the Smart Grid Controller, DHW and Heating operate according to user settings.

Pattern 2: Switch ON recommendation

When set to the "Switch ON" recommendation, the target temperature of DHW is increased a specified amount and the heating "Thermo ON" condition range is extended.

Pattern 3: Switch OFF command

When the "Switch OFF" command is received, both DHW and Heating are turned off.

Pattern 4: Switch ON command

When the "Switch ON" command is received, the target temperature of DHW is increased to the maximum target temperature and Heating continues.

Improved Smart Grid Ready Function

SG ready icon on main remote controller indicates that SG ready is active and its setting can be easily operated with main remote controller. Improved SG ready function enables you to choose the target temperature by 1°C steps. Also, when PV manager is interlocked with ecodan and ecodan receives its signal, heat is stored as much as possible while heat pump and/or electric heater is/are operating.

Heat storage in large buffer tank will be made available well when peak cut signal is on. As long as a mixing valve keeps its control, temperature is maintained.

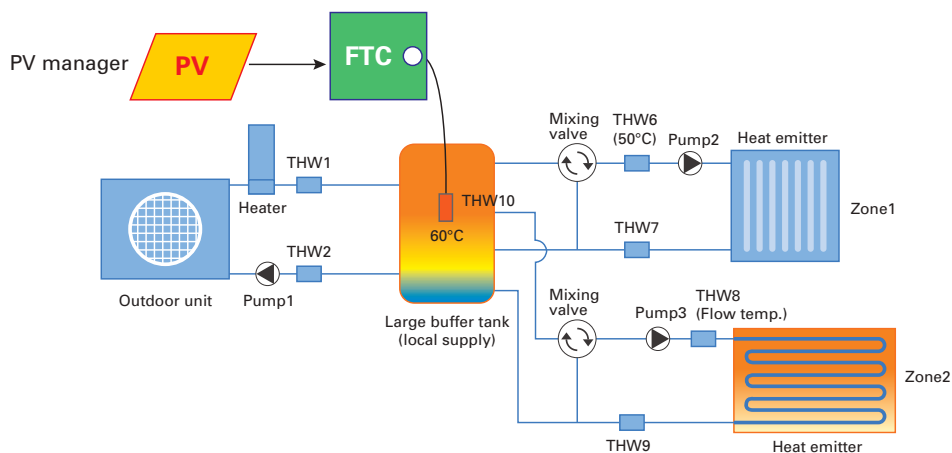
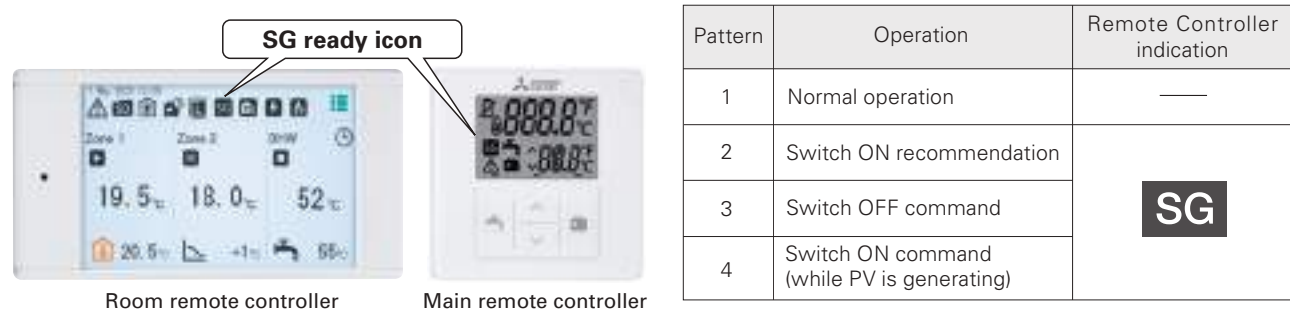

Main Remote Controller E generation

Simple User-friendly Controller with New Design

- New design for simple and intuitive operation
- Color display and touch screen for excellent visibility
- Multi-language support (supports 24 languages)
- Wide range of convenient functions in response to user demand

Function settings

- Energy monitoring
- Two-zone control (cooling and heating)
- Two separate schedules
- Built-in room temperature sensors
- Hybrid control (boiler interlock)
- Floor drying mode
- Weekly timer
- Holiday mode
- Legionella prevention
- Error codes



Display All Necessary Information from the Home Screen

New main remote controller shows all information at a glance on the home screen so that users do not need to spend time looking for the information they want.

2 zone display on 1 screen

New incrementation 0.5°C that gives you more accurate information and comfort.

Actual temperature 19.5°C
Target temperature 20.5°C

Schedule is ON

DHW production: ON / OFF

Recognizable icons & colors

- Heat pump status with direct expression icons
- Control logic with color indication

Running Defrost Quiet mode with level Emergency heating Heating Cooling Not running

Improved Usability for Intuitive Operation

- Multiple settings all at once

New main remote controller combines the related 4 settings in one screen to avoid back and forth navigation. This contributes to time savings and comfort as it eliminates the need to confirm in each setting.



- Simplified schedule setting

An intuitive schedule setting screen is now adopted, removing the previous complex setting. The timeline is easily cognizable and permission or prohibition of heating and cooling for 2 seasons can be set at once.

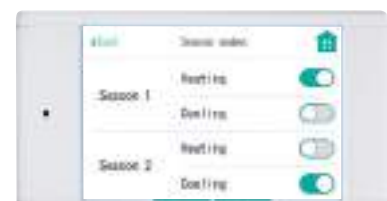

Wireless Remote Controller (Optional) NEW

Smart User-friendly Controller with Stylish Design



- Remote control from any room with flexible installation location
- Built-in room temperature sensor; easy to place at various positions to detect the room temperature
- New sleek designed flat panel and touch buttons for intuitive operation
- Easy-to-read LCD screen and big buttons for better usability
- No cabling required thanks to wireless connectivity
- Domestic hot water boost and cancellation function
- Holiday mode settings for up to 72 hours on hourly basis for energy saving with simple operation
- Room temperature is controlled according to the temperature monitored in a selected room
- Up to 8 wireless remote controllers connectable
- Floor-to-floor wireless transmission such as from basement to floor level

New Screen Display with Touch Buttons

- SG-ready icon added
- Each icon unified with the design of the main remote controller
- An LED light is added to notify users instantly if an error or malfunction occurs

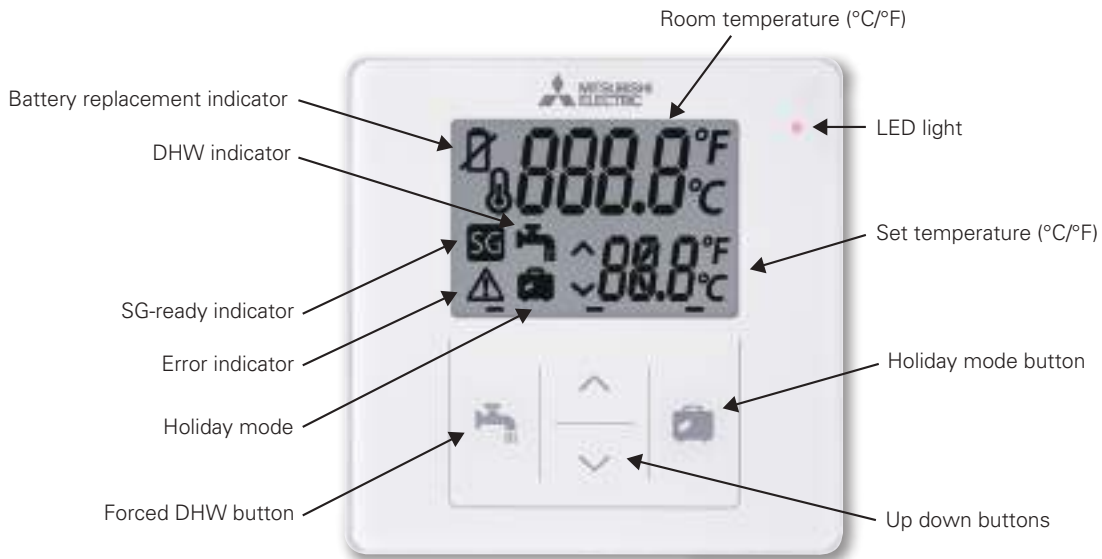

Flexible Installation

You can choose to mount it on the wall or place it on a stand. The stand design is renewed as well as the functionality.



Wall-mounted*



Standing

* The included screws are installed in this image.

System Error LED Display

A red LED for error indication is added to notify users of abnormal conditions such as backup heater operation or low battery level.



Mode	Flash
Failed*	3 times per 1 minute
Back up heater operation	
Low battery	1 time per 3 minutes

* When any malfunction occurs in indoor unit, outdoor unit, remote controller or receiver.

ZUBADAN SERIES

The ZUBADAN Series incorporates an original Flash Injection technology that improves the already high heating capacity of the system. This new member of the series line-up ensures comfortable heat pump-driven heating performance in cold regions.



* Units in photo are Japanese models.
European model specifications are different.

Improved Heating Performance

Mitsubishi Electric's unique "Flash Injection" circuit achieves remarkably high heating performance. This technology with the old R410A units has resulted in an excellent heating capacity rating at outdoor temperatures as low as -15°C , and the guaranteed heating operation range of the heating mode has been extended to -25°C . Accordingly, the heat-pump units of the ZUBADAN Series are perfect for warming homes in the coldest of regions.

With the new R32 units, PUZ-SHWM, this technology has achieved extremely remarkable results. At -7°C , a water supply temperature of 70°C is possible, and at -15°C , a supply temperature of 60°C can be maintained. The most notable result is the ability to operate at temperatures as low as -30°C with a supply temperature that remains at 50°C .

Enhanced Comfort

The Flash Injection circuit improves start-up and recover from the defrosting operation. A newly introduced defrost operation control also improves defrost frequency. These features enable the temperature to reach the set temperature more quickly, and contribute to maintaining it at the desired setting.

Quick Start-up

■ Operation at $+2^{\circ}\text{C}$ outdoor temperature

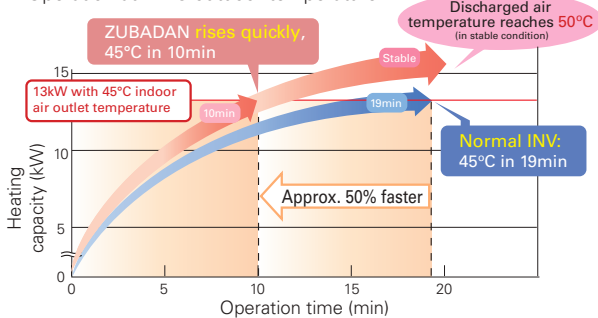

■ Operation at -20°C outdoor temperature

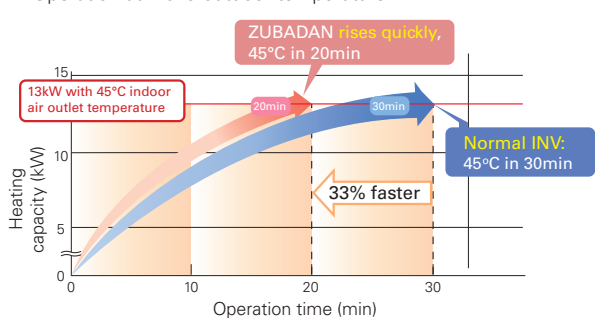

ZUBADAN Defrost Control and Faster Recovery from Defrost Operation Field Test Results: Office building in Asahikawa, Hokkaido, Japan

■ Operation data for 25 Jan. 2005

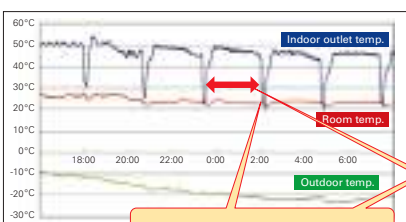

■ Operation data for 2 Dec. 2004

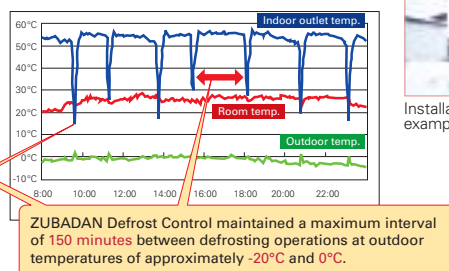

Installation example



Mitsubishi Electric's Flash Injection Technology The Key to High Heating Performance at Low Outdoor Temperatures

Flash Injection Circuit

ZUBADAN

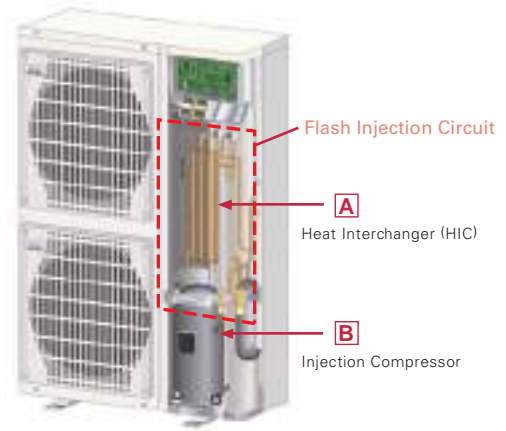
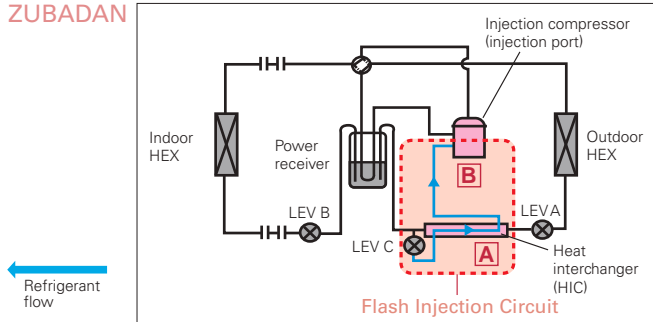

The ZUBADAN Series is equipped with Mitsubishi Electric's original Flash Injection Circuit, which is comprised of a bypass circuit and heat interchanger (HIC). The HIC transforms rerouted liquid refrigerant into a gas-liquid state to lower compression load. This process ensures excellent heating performance even when the outdoor temperature drops very low.

In traditional units, when the outdoor temperature is low, the volume of refrigerant circulating in the compressor decreases due to the drop in refrigerant pressure and the protection from overheating caused by high compression, thereby reducing heating capacity. The Flash Injection Circuit injects refrigerant to maintain the refrigerant circulation volume and compressor operation load, thereby maintaining heating capacity.

Mollier Chart Image Representing Flash Injection Circuit Operation

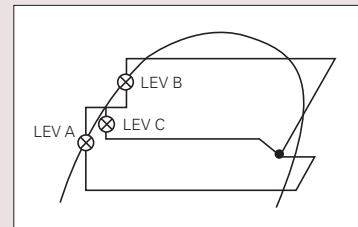

A Heat Interchanger (HIC)

HIC cross-sectional view

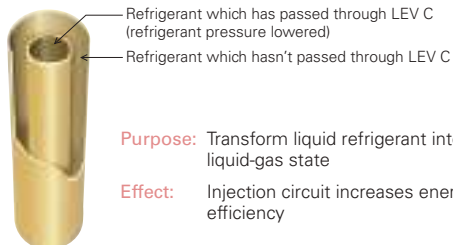

The compressor is subjected to a heavy load when compressing liquid refrigerant, and the result is lower operation efficiency. The addition of HIC supports refrigerant heat exchange at two different pressure levels. The heat-exchange process transforms the injected liquid refrigerant into a gas liquid state, thereby decreasing the load on the compressor during the compression process.

B Injection Compressor

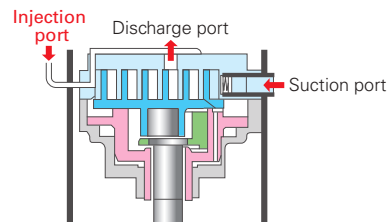

Purpose: To increase the volume of refrigerant being circulated

Effect: Improves heating capacity at low outdoor temperatures, and enables higher indoor-air outlet temperature adjustment and higher defrost operation speed

Refrigerant passes from the HIC into the compressor through the injection port. Having two refrigerant inlets makes it possible to raise the volume of refrigerant being circulated when the outdoor temperature is low and at the start of heating operation.

To ensure full capacity in cold and snowy regions...

3 Important Points to Remember When Installing the Outdoor Unit



* RAC/PAC (inc. Air to Water) /MXZ

Wind and snow can significantly reduce capacity.

Be sure to check the information below and install the outdoor unit correctly.

1 Installation Location

Be aware of the prevailing wind direction in winter and install the outdoor unit where it is as sheltered as possible.

Units are easily affected by wind and unit may not be able to run at full capacity

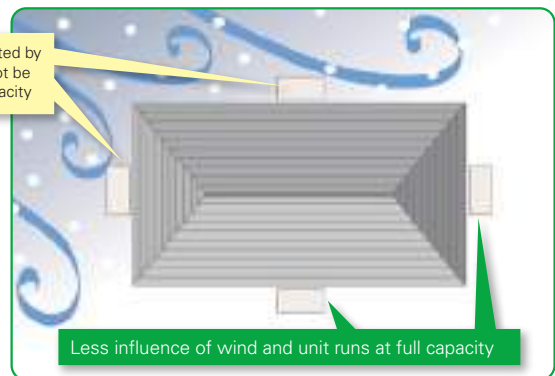

2 Measures for Drainage of Water

Case 1: Unit is installed close to passage (walkway)

Do not install the unit close to passage as drainage water from the unit may freeze and cause a slipping hazard.

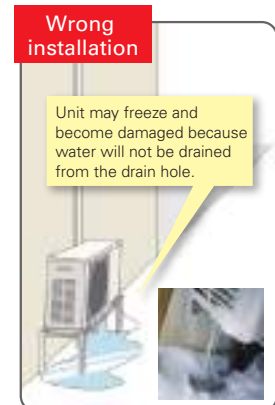
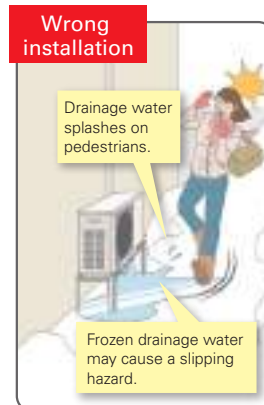
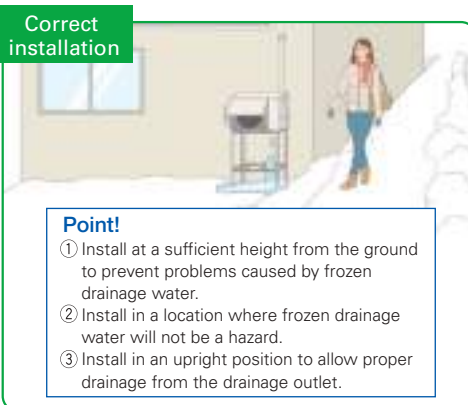

Case 2: Multiple units are installed

Do not install units on top of one another as it may cause frozen drainage water on the bottom unit.

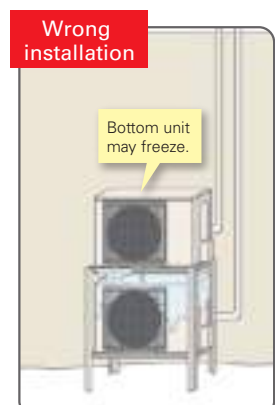
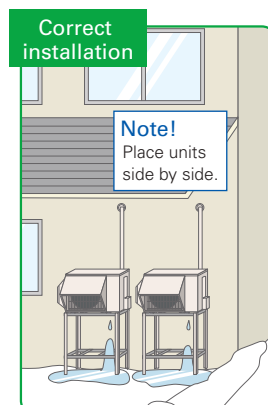

3

Measures for Snow

Unit is installed on the ground

To avoid the adverse effects of snow and frozen drainage water, install the unit on a stand to ensure a sufficient height from the ground.

Correct installation

Point!

- Install at a position/height to prevent the unit being buried in snow*1 and the adverse effects of frozen drainage water.*2
- Install so as to avoid the effects of snow or snowdrift.
- Install so as to avoid the damage from falling snow or icicles.

*1 Install at a height above the highest snowfall depth.
*2 Even for correct installations, dripping drainage water may form an icicle which needs to be cleared away regularly to prevent a blocked drainage outlet.

Wrong installation

Unit may become buried in snow due to heavy snowfall, snow sliding off the roof or snowdrift.

Wrong installation

Unit may be damaged due to snowfall or icicles.

Use a stand to add sufficient height to protect the unit heat exchanger from snow and prevent icicles forming during defrost operation.

Install snow protection hood as necessary

Correct installation

Minimum height (h) should be higher than the highest snowfall depth (h0) **+20cm**

Wrong installation

Unit may become covered in snow if the stand height is insufficient.

Correct installation

Point!
Install the snow protection hood or other cover in snowy regions.

Necessity of accessories (drain socket & centralised drain pan, stand, snow protection hood, base heater)

	Snowy region	Cold region	Remarks
	Countermeasures for snow	Countermeasures for freezing	
Drain socket, Centralised drain pan	Not used	Not used	Prevents freezing
Stand	Needed	Needed	<ol style="list-style-type: none"> Install so as to prevent the unit being buried in snow (at a height greater than the highest snowfall depth). Be sure that the stand does not obstruct drainage. Install so as to prevent damage to the unit due to frozen drainage water (icicles). <div style="text-align: right;"> <p>Clearance to prevent snow accumulating. < Correct ></p> </div>
Snow protection hood	Needed *When the installation position is subject to snowfall.	—	<ol style="list-style-type: none"> Prevents heat exchanger from being covered in snow. Prevents snow accumulating inside the air duct.
Base heater	—	Needed	Outdoor units equipped with a heater for cold regions are those with an "H" in the model name. For the cold-climate zone, use of a unit with a heater is strongly recommended. Even for the moderate-climate zone use of a unit with a heater is recommended for regions subject to high humidity in winter.



CAUTION

About disposal of drainage water

When the unit is installed in cold or snowy regions :

Drainage water may freeze in the drain socket/hose and prevent the fan from rotating.



Do not attach a drain socket packaged as an accessory to the unit.

* In the case that fitting a drain socket is absolutely necessary, steps must be taken so that the drainage water does not freeze. For more information, please consult Mitsubishi Electric or one of its dealers/resellers.

PXZ SERIES

Air-to-Air and Air-to-Water Hybrid Multi Split System

1 Unit, 2 Roles – Total Comfort Year-round

Air Conditioning and Hot Water Supply Matching Every Home's Needs

All-in-one outdoor unit: air conditioning, domestic hot water supply and hot water heating



PXZ for summer

PXZ enables cooling of multiple rooms by ATA and supply hot water by ATW.



PXZ for winter

PXZ enables heating of multiple rooms by ATA and supply hot water by ATW.

Indoor unit line up

Air-to-Air Wall-mounted

MSZ-LN



MSZ-EF



MSZ-AP



Floor-standing

MFZ



1-way Cassette

MLZ



Ceiling-concealed

PEAD



SEZ



Ceiling-suspended

PCA



Air-to-Water Ecodan Hydrobox/Cylinder



Usage Patterns All-in-one System Solution

Summer 2-in-1 Operation

Secure total indoor comfort by cooling with ATA and producing DHW by ATW in summer. During the times your ATA is not cooling, your heat pump will produce DHW stored in your tank. Hot summer days will become a breeze with cooling ATA and you can enjoy DHW for all your needs with ATW.

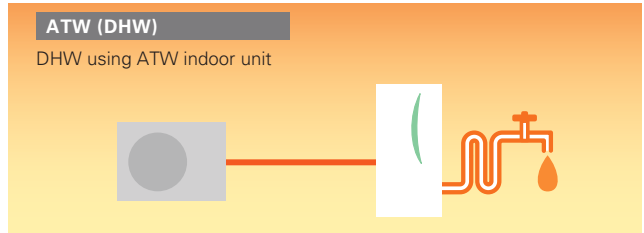
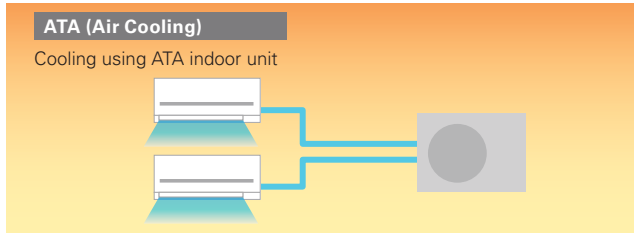

Spring & Autumn 2-in-1 Operation

Secure total indoor comfort by heating with ATA and producing DHW by ATW in spring and autumn. During the times your ATA is not heating, your heat pump will produce DHW stored in your tank. ATA will quickly warm up your room even during the chilly morning and evening and you can enjoy DHW for all your needs with ATW.

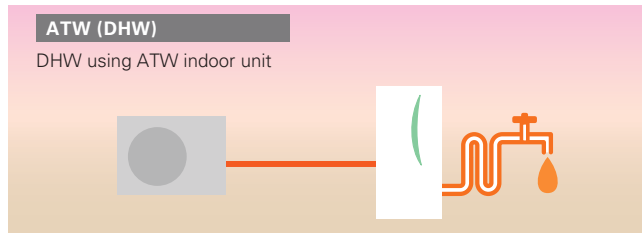
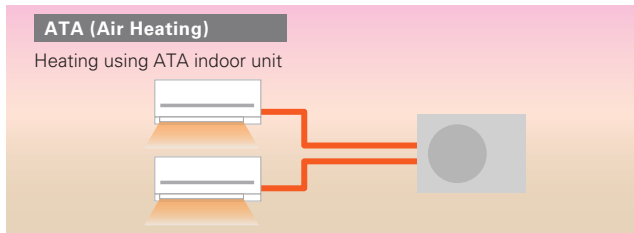

Winter ecodan

Secure total indoor comfort by heating and producing DHW by ATW in winter. During the times your ATW is not heating, your heat pump will produce DHW stored in your tank. ATW heating will keep your home warm all the day in severe cold weather and you can enjoy DHW for all your needs with ATW.

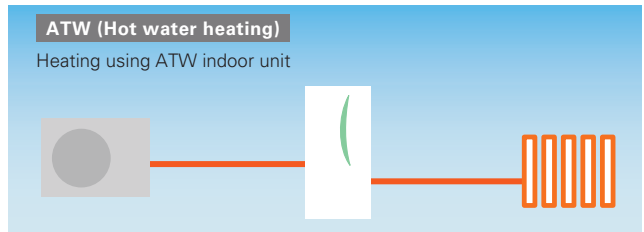
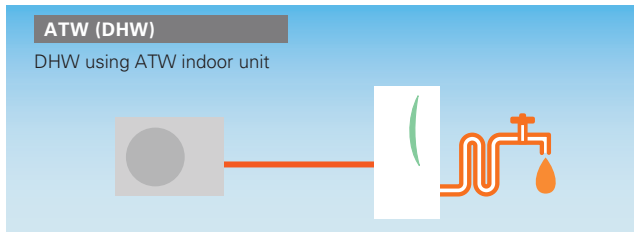

* If DHW operation starts during ATA operation, ATA operation will temporarily stop. Therefore, it is recommended to set a schedule timer so that DHW operates during the night or when you are not at home.

Outdoor unit line up

Compact design fitting into narrow spaces, ideal for condominiums and villas.

New system PXZ

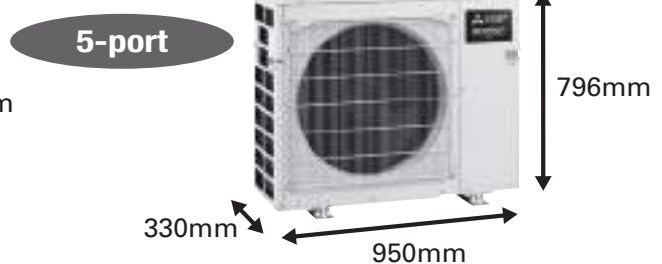
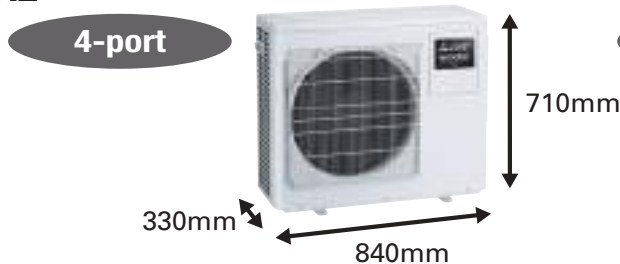

Quiet mode

Quiet mode allows PXZ to run silently while cooling or heating your home.

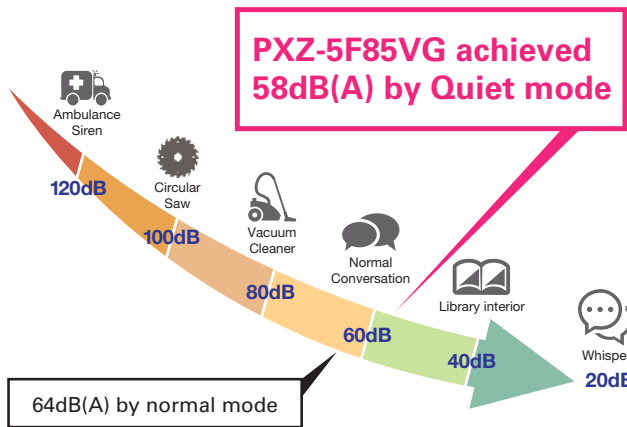

- * The cooling and heating capacity may drop if this function is activated.
- * When the outside air temperature is low during heating, the heating capacity is prioritized and the unit may not be quiet. Also, if the outside air temperature is high during cooling, the cooling capacity is prioritized and the unit may not be quiet.
- * Sound power level values are based on EN12102.
- * Capacity values are based on EN14511
- * To activate Quiet mode, changing the setting is required.

Max 55°C outlet water temp

For the hot water supply with PXZ, a maximum outlet water temperature of 55°C is secured.

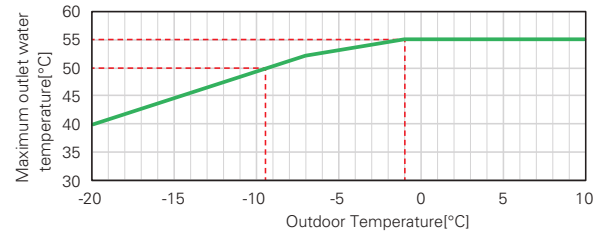

High Performance Hot Water Supply

ErP Lot 1 Compliant with highest seasonal space heating energy efficiency class A++.



Low GWP refrigerant R32 contributes the reduction of CO₂ emission compared with conventional R410A refrigerant.

A+++ Class Energy Efficiency

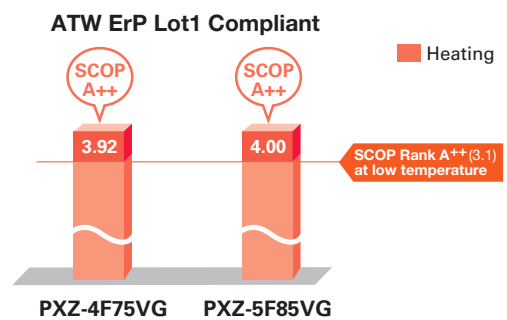
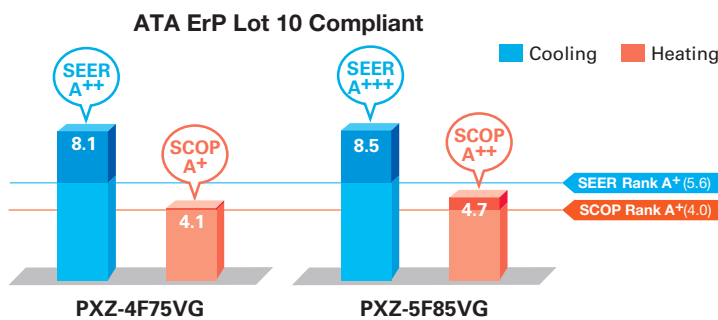

New System Benefits

End users only need to purchase a single outdoor unit, as PXZ is connectable to both RAC and Ecodan. With house expansions or room redistributions, additional indoor units can be installed in the future.

Current system MXZ + ecodan

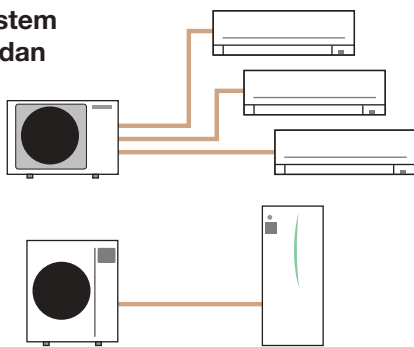

Footprint

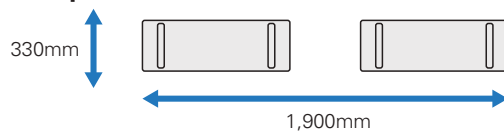

New system PXZ

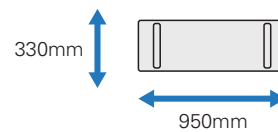
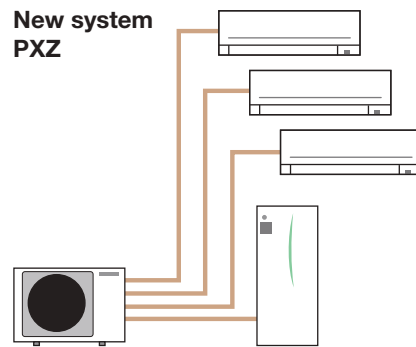

1/2 space !

And more benefits like...



Cost saving by reducing the number of systems.



Additional indoor units up to 4 or 5 ports can be installed.

Specifications

PXZ-4F75VG

Maximum Piping Length	
Outdoor unit - Indoor unit (a,b,c,d)	30m
Total length (a+b+c+d)	60m

Maximum Number of Bends	
Outdoor unit - Indoor unit (a,b,c,d)	25
Total number (a+b+c+d)	60

Indoor units

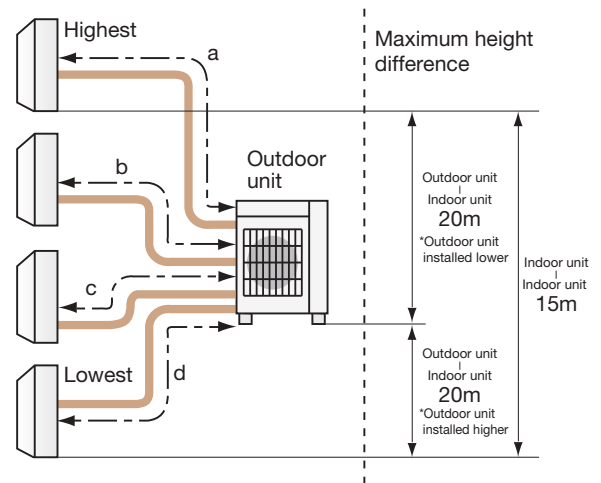

PXZ-5F85VG

Maximum Piping Length	
Outdoor unit - Indoor unit (a,b,c,d)	30m
Total length (a+b+c+d)	70m

Maximum Number of Bends	
Outdoor unit - Indoor unit (a,b,c,d)	25
Total number (a+b+c+d)	70

Indoor units

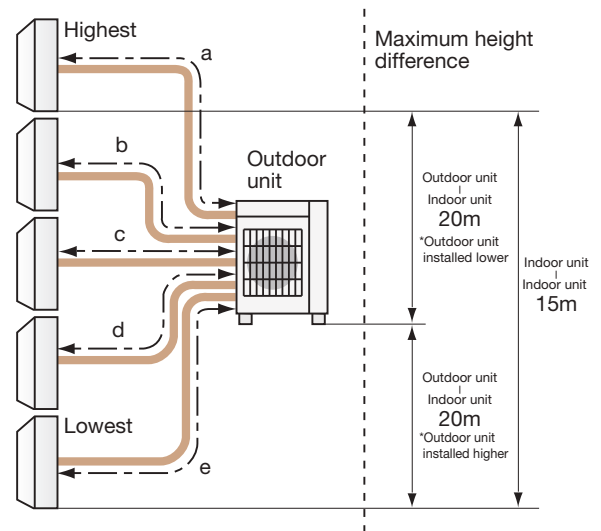

Specifications

Outdoor Unit				PXZ-4F75VG	PXZ-5F85VG		
Air-to-Air (ATA)	Cooling	Capacity	Rated (35°C)	kW	7.2	8.3	
			Min-Max	kW	3.7-8.8	3.7-9.2	
		Total Input	Rated (35°C)	kW	1.85	1.97	
		EER			3.89	4.21	
		Design load		kW	7.2	8.3	
		Annual electricity consumption*1		kWh/a	311	342	
		SEER*2			8.1	8.5	
				Energy efficiency class		A++	A+++
		Heating	Capacity	Rated (7°C)	kW	8.6	9.3
				Rated (-7°C)	kW	6.20	6.20
	Min-Max (7°C)			kW	3.4-10.7	3.4-11.6	
	Total Input		Rated (7°C)	kW	1.87	2.00	
	COP				4.60	4.65	
	Design load			kW	7.0	7.0	
	Declared Capacity		at reference design temperature	kW	5.6	5.8	
			at bivalent temperature	kW	6.2	6.2	
			at operation limit temperature	kW	4.8	4.9	
	Back up heating capacity			kW	1.4	1.2	
	Annual electricity consumption*1		kWh/a	2,389	2,087		
	SCOP*2			4.1	4.7		
		Energy efficiency class		A+	A++		
Sound Level (SPL)	Cooling		dB(A)	48	49		
	Heating		dB(A)	54	51		
Sound Power Level (PWL)	Cooling		dB(A)	63	61		
	Heating		dB(A)	69	63		
Outdoor unit	Supply(V/Phase/Hz)	230V/1 phase/50Hz					
	Air Volume	ATA heating	m3/min	42.7	62		
		ATA Cooling	m3/min	35.4	57		
		ATW heating	m3/min	42.7	62		
		ATW DHW (ecodan indoor unit)	m3/min	42.7	62		
	Guaranteed Operating Range	ATA heating	°C	-20°C DB-24°C DB	-20°C DB-24°C DB		
		ATA Cooling	°C	-10°C DB-46°C DB	-10°C DB-46°C DB		
		ATW heating	°C	-20°C DB-24°C DB	-20°C DB-24°C DB		
		ATW DHW (ecodan indoor unit)	°C	-20°C DB-35°C DB	-20°C DB-35°C DB		
	Dimensions	H×W×D	mm	710×840(+30)×330(+66)	796×950×330		
	Weight		kg	59	62		
	Packaged Dimension	H×W×D	mm	870×1010×460	950×1050×440		
	Packaged Weight		kg	68	74		
	Operating Current (max)		A	18	21.4		
	Breaker Size		A	25	25		
Ext.Piping	Diameter	Liquid/Gas	mm	6.35x4/12.7x1+9.52x3	6.35x5/12.7x1+9.52x4		
	Each indoor unit piping length (max)		m	30	30		
	Max.Length	Out-In	m	60	70		
	Max.Height	Out-In	m	20	20		
	Chargeless length		m	60	70		
Refrigerant	Amount	Pre-charged	kg	2.4	2.4		
	Maximum		kg	2.4	2.4		
Number of total port	Available indoor unit ATA	Quantity		1~3	1~4		
	Available indoor unit ATW	Quantity		1	1		
ecodan connection (Mitsubishi Electric supplied indoor unit)	Heating*4	A7W35	Capacity nom	kW	7.5	8.5	
			Capacity max	kW	9.3	10.0	
		Total Input nom	kW	1.80	1.96		
		Total Input max	kW	2.61	2.51		
		COP nom		4.17	4.34		
		COP max		3.57	3.99		
		A7W55	Capacity	kW	7.50	8.50	
			Total Input	kW	3.05	3.26	
			COP		2.46	2.61	
		A2W35	Capacity nom	kW	6.80	7.80	
			Capacity max	kW	6.80	7.80	
			Total Input nom	kW	2.43	2.60	
			Total Input max	kW	2.43	2.60	
			COP nom		2.80	3.00	
	COP max		2.80	3.00			
	SSHE 35°C Average condition	Class		A++	A++		
		ηS		154%	157%		
		SCOP		3.92	4.00		
		Class		A+	A+		
	SSHE 55°C Average condition	Class		A+	A+		
		ηS		113%	111%		
		SCOP		2.91	2.86		
		Class		A+	A+		
	DHW (ecodan indoor unit)	DHW 200L Load Profile	Class	A+	A+		
		Average condition	ηWH	124%	122%		
		COP DHW		2.99	2.97		
	Max outlet water temperature		°C	55	55		
Sound Level (SPL)	Heating		dB(A)	57	54		
	DHW (ecodan indoor unit)		dB(A)	57	54		
Sound Power Level (PWL)	Heating		dB(A)	67	64		
	DHW (ecodan indoor unit)		dB(A)	67	64		

*1 Energy consumption is based on standard test results. Actual energy consumption will depend on how the appliance is used and where it is located.

*2 SEER/SCOP values are measured based on EN14825.

*3 Refrigerant leakage contributes to climate change. Refrigerant with lower global warming potential (GWP) would contribute less to global warming than a refrigerant with higher GWP, if leaked to the atmosphere. This appliance contains a refrigerant fluid with a GWP equal to 675. This means that if 1 kg of this refrigerant fluid would be leaked to the atmosphere, the impact on global warming would be 675 times higher than 1 kg of CO₂, over a period of 100 years. Never try to interfere with the refrigerant circuit yourself or disassemble the product yourself and always ask a professional. The GWP of R32 is 675 in the IPCC 4th Assessment Report.

*4 Air-to-Water values are measured based on EN14511 (Circulation pump input is not included.).

PXZ + ecodan ATA Compatibility Table

Indoor unit		Outdoor unit	PXZ	
			4F75VG	5F85VG
M series	Wall Mounted	MSZ-RW25VG	○	○
		MSZ-RW35VG	○	○
		MSZ-RW50VG	○	○
		MSZ-LN18VG2	○	○
		MSZ-LN25VG2	○	○
		MSZ-LN35VG2	○	○
		MSZ-LN50VG2	○	○
		MSZ-LN60VG2		
		MSZ-EF18VG(K)	○	○
		MSZ-EF22VG(K)	○	○
		MSZ-EF25VG(K)	○	○
		MSZ-EF35VG(K)	○	○
		MSZ-EF42VG(K)	○	○
		MSZ-EF50VG(K)	○	○
		MSZ-AP15VG(K)	○	○
		MSZ-AP20VG(K)	○	○
		MSZ-AP25VG(K)	○	○
		MSZ-AP35VG(K)	○	○
		MSZ-AP42VG(K)	○	○
		MSZ-AP50VG(K)	○	○
		MSZ-AP60VG(K)	○	○
		MSZ-AP71VG(K)	○	○
		MSZ-AY25VGK(P)	○	○
	MSZ-AY35VGK(P)	○	○	
	MSZ-AY42VGK(P)	○	○	
	MSZ-AY50VGK(P)	○	○	
	MSZ-BT20VG(K)	○	○	
	MSZ-BT25VG(K)	○	○	
	MSZ-BT35VG(K)	○	○	
	MSZ-BT50VG(K)			
	Floor Standing*1	MFZ-KT25VG	○	○
		MFZ-KT35VG	○	○
		MFZ-KT50VG	○	○
1-way Cassette*2	MLZ-KP25VF	○	○	
	MLZ-KP35VF	○	○	
	MLZ-KP50VF	○	○	
	MLZ-KY20VG	○	○	
S series	Ceiling Concealed	SEZ-M25DA(L)	○	○
		SEZ-M35DA(L)	○	○
		SEZ-M50DA(L)	○	○
		SEZ-M60DA(L)	○	○
		SEZ-M71DA(L)		○
		SEZ-M25DA(L)2	○	○
		SEZ-M35DA(L)2	○	○
		SEZ-M50DA(L)2	○	○
		SEZ-M60DA(L)2	○	○
		SEZ-M71DA(L)2		○
P series	Ceiling Suspended*3	PCA-M50KA	○	
		PCA-M60KA	○	
		PCA-M71KA		
		PCA-M50KA2	○	
		PCA-M60KA2	○	
Ceiling Concealed*3	PEAD-M50JA(L)	○	○	
	PEAD-M60JA(L)	○	○	
	PEAD-M71JA(L)	○	○	

*Total ATA IU HEX volume should NOT exceed a certain level. Please contact us for the further information.

- *1 When connecting to MFZ, MAC-001MF is required to install to suppress noise.
- *2 When connecting to MLZ, electric heater is required for outlet water temperature over 40°C.
- *3 When connecting to PEAD-M60/71 or PCA-M60/71, it is prohibited to connect other ATA.

PXZ + ecodan ATW Compatibility Table

Indoor unit		Outdoor unit	PXZ	
			4F75VG	5F85VG
Cylinder	EHST17D-VM2D	○	○	
	EHST17D-YM9D	○	○	
	EHST20D-VM2D	○	○	
	EHST20D-VM6D	○	○	
	EHST20D-YM9D	○	○	
	EHST20D-YM9ED	○	○	
	EHST20D-TM9D	○	○	
	EHST30D-VM6ED	○	○	
	EHST30D-YM9ED	○	○	
	EHST30D-TM9ED	○	○	
	ERST17D-VM2D	○	○	
	ERST17D-VM6D	○	○	
	ERST20D-VM2D	○	○	
	ERST20D-VM6D	○	○	
	ERST20D-YM9D	○	○	
	ERST30D-VM2ED	○	○	
	ERST30D-VM6ED	○	○	
	ERST30D-YM9ED	○	○	
Hydrobox	EHSD-VM2D	○	○	
	EHSD-VM6D	○	○	
	EHSD-YM9D	○	○	
	EHSD-YM9ED	○	○	
	EHSD-TM9D	○	○	
	ERSD-VM2D	○	○	
	ERSD-VM6D	○	○	
	ERSD-YM9D	○	○	

New Optional Parts Compatibility Table

Parts name	Model name	PXZ	
		4F75VG	5F85VG
Drain hose heater connector	MAC-062RA-E	○	○
Muffler*	MAC-001MF-E	○	○

*Please connect the muffler to the gas piping within 3 meters from the piping connection port of the outdoor unit.

*Please attach this if you are concerned about refrigerant noise.

PUMY+ecodan

Air-to-Air and Air-to-Water Hybrid Multi Split System

1 Unit, 2 Roles – Total Comfort Year-round

Air Conditioning and Hot Water Supply Matching the Needs of Each Room

All-in-one outdoor unit (air conditioning, domestic hot water supply and hot water heating)

PUMY for Air-to-Air

PUMY utilises various indoor units, enabling the air conditioning or heating of multiple rooms, and controls each unit individually.

ecodan for Air-to-Water

- ✓Domestic hot water (DHW) supply
- ✓Heating for multiple rooms

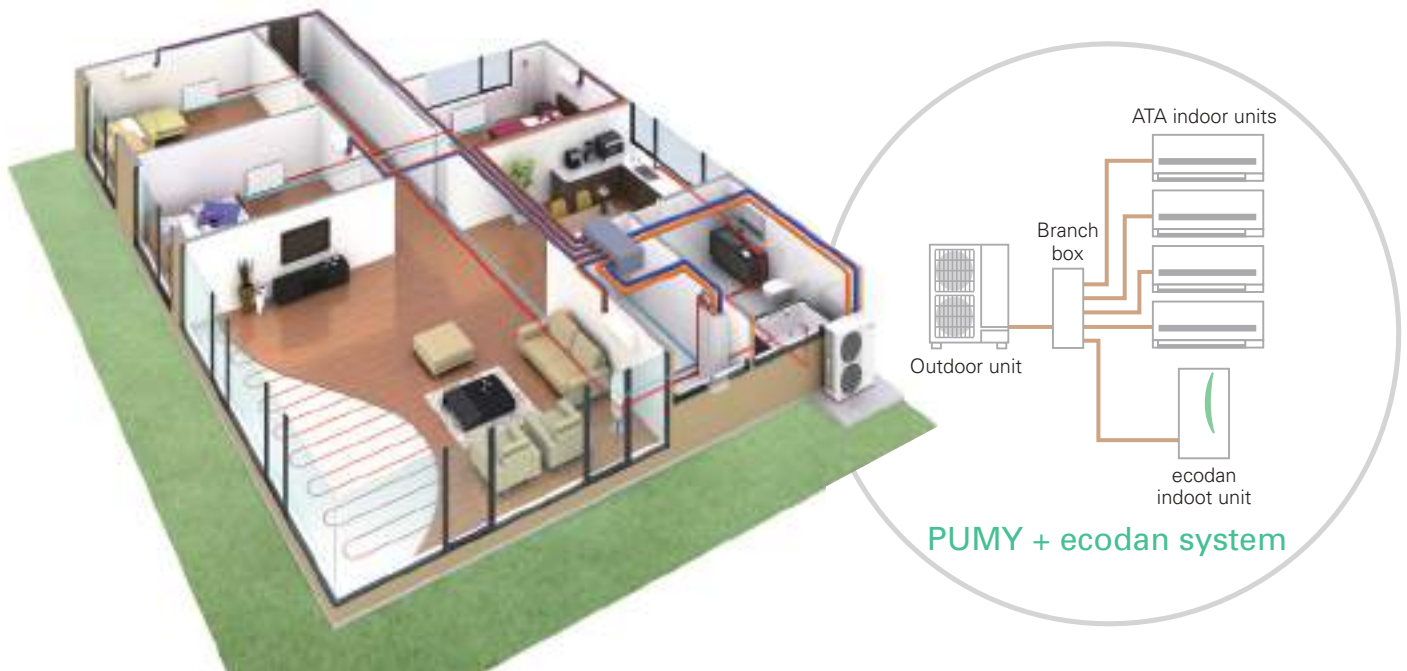

Main Operation Patterns

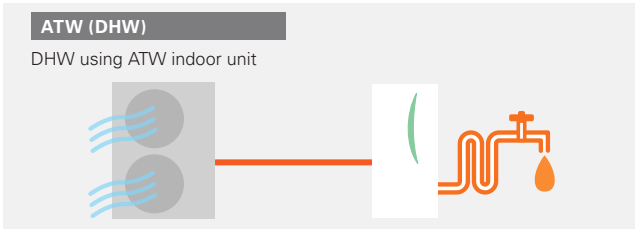
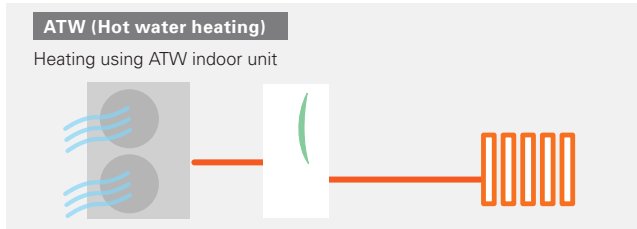
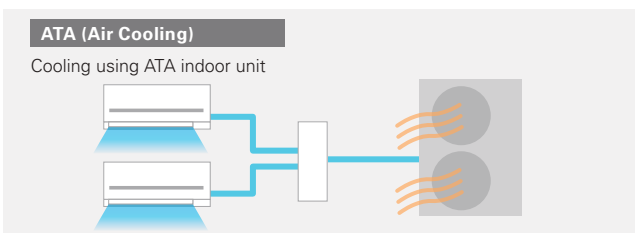
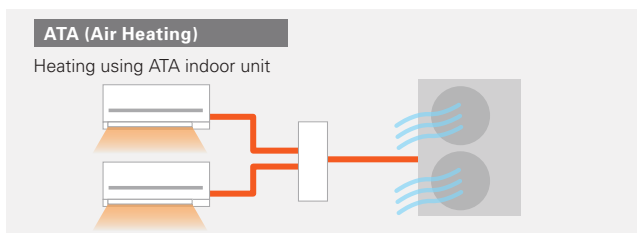

Optional Operation Patterns* (simultaneous)

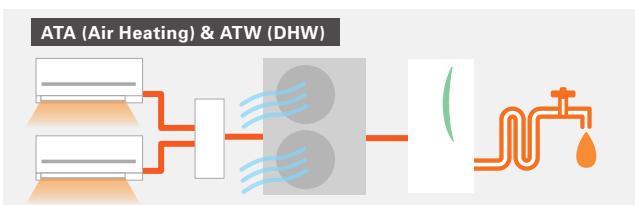
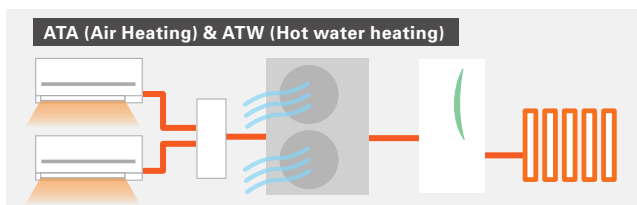

*When using optional simultaneous operation, there are some restrictions, such as connectable indoor units, operation range and DHW flow temp.

Usage Pattern All-in-one System Solution

Summer 2-in-1 Operation

In summer ATA cooling and DHW are utilised. Keep your room comfortable with ATA cooling during high temperature daytime. Heat pump operates to heat up water stored in the DHW tank when ATA is not operated. The hot water can be utilised for shower and washing dishes during daytime.

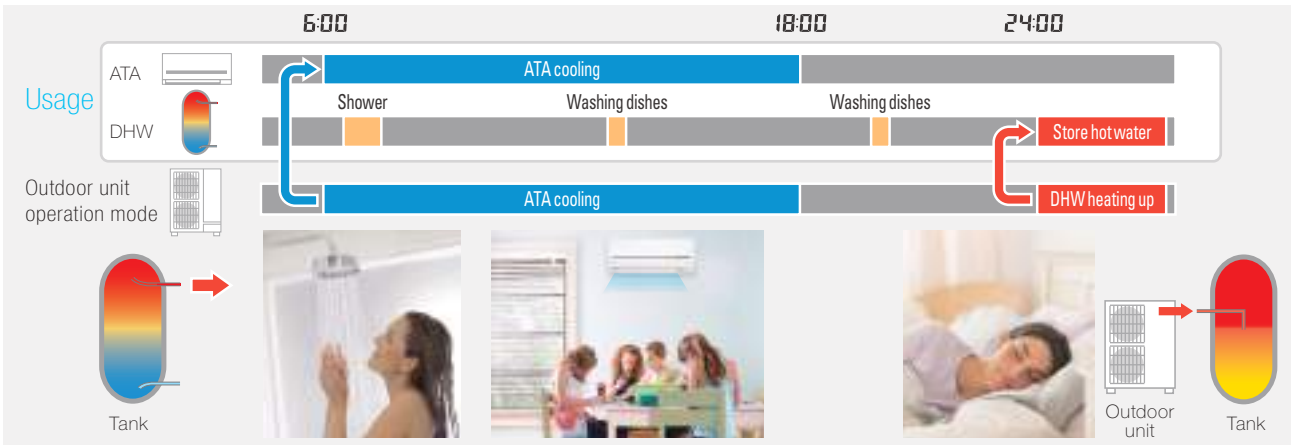

Spring & Autumn 2-in-1 Operation

In spring and autumn, ATA heating and DHW are utilised. ATA heating can warm up each room quickly during the low temperature morning and evening. Heat pump operates to heat up water stored in the DHW tank when ATA is not operated. The hot water can be utilised for shower and washing dishes during daytime.

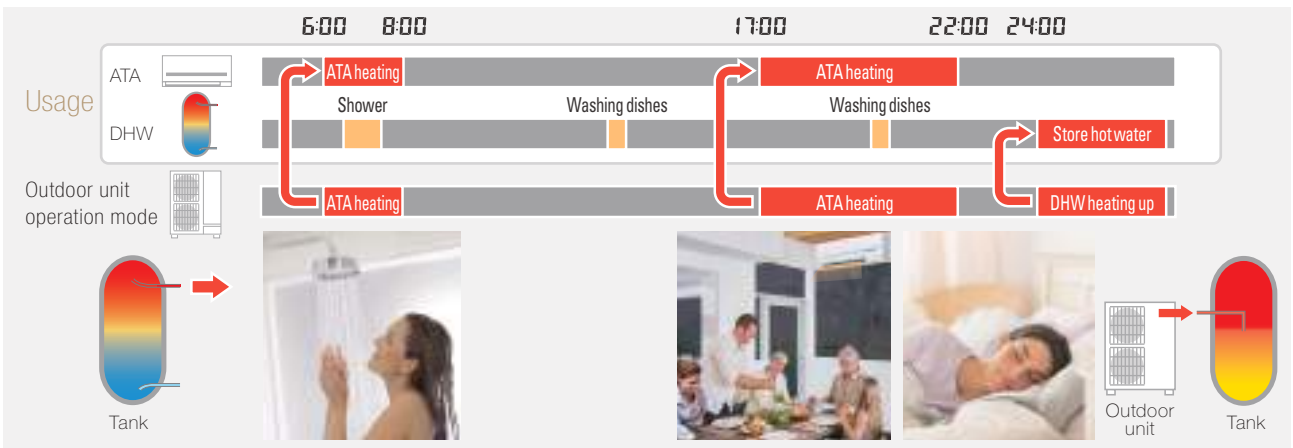

Winter ecodan

In winter ATW heating and DHW are utilised. ATW heating warms home all the day in severe cold weather. ATW heating stops temporarily only when the heat pump operates to heat up water stored in the DHW tank.

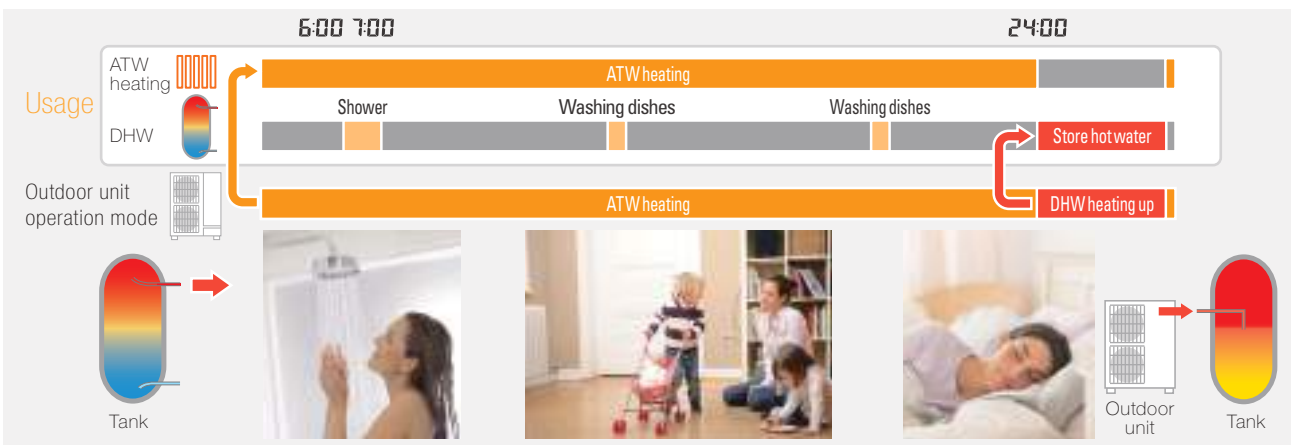

Model name				PUMY-P112VKM6	PUMY-P125VKM6	PUMY-P140VKM6	PUMY-P112YKM5	PUMY-P125YKM5	PUMY-P140YKM5	
Power supply				1-phase 220 - 230 - 240V, 50Hz			3-phase 380 - 400 - 415V, 50Hz			
Air-to-Air (ATA)	Cooling (nominal)*1	Capacity	kW	12.5	14.0	15.5	12.5	14.0	15.5	
		Power input	kW	4.34	5.00	5.17	4.34	5.00	5.17	
		EER		2.88	2.80	3.00	2.88	2.80	3.00	
	Temp. range of cooling	Indoor temp.	W.B.	15 - 24°C						
		Outdoor temp.*2	D.B.	-5 - 52°C						
	Heating (nominal)*1	Capacity	kW	14.0	16.0	18.0	14.0	16.0	18.0	
Power input		kW	3.49	4.06	4.63	3.49	4.06	4.63		
COP			4.01	3.94	3.89	4.01	3.94	3.89		
Temp. range of heating	Indoor temp.	W.B.	15 - 27°C							
	Outdoor temp.	D.B.	-20 - 15°C							
Air-to-Water (ATW)	Nominal flow rate (for heating)			L/min	35.8					
	Heating*3	A7W35	Capacity	kW	12.5					
			Power input	kW	3.06					
			COP		4.08					
	A2W35	Capacity	kW	10.0						
		Power input	kW	3.50						
		COP		2.86						
	Guaranteed operating range	ATA	Heating	D.B.	-20 - +21°C					
			DHW	D.B.	-20 - +35°C					
			ATA heating + DHW	D.B.	7 - +21°C					
ATA + ATW	ATA heating + ATW heating *4	D.B.	-10 - +21°C							
	Maximum Outlet water temp.			°C	55					
Outdoor unit	Indoor unit connectable	ATA only	Total capacity		50 to 130% of outdoor unit capacity					
			Model/Quantity	Branch box system	15-100/8	15-100/8	15-100/8	15-100/8	15-100/8	15-100/8
		ATA + ATW individual operation	Total capacity		ATA : Max 130% of outdoor unit capacity + ATW (EHST20C or EHSC) *7					
			Model/Quantity (including ATW)	Branch box system	15-100/8	15-100/8	15-100/8	15-100/8	15-100/8	15-100/8
	ATA + ATW simultaneous operation	Total capacity		Max 100% of outdoor unit capacity : ATA + ATW (EHST20C or EHSC) *7						
		Model/Quantity	ATA*12	15/1*8	15-25/2*9	15-42*11/3*10	15/1*8	15-25/2*9	15-42*11/3*10	
			ATW	ATW (EHST20C or EHSC) / 1						
	Sound pressure level (measured in anechoic room)			dB<A>	49 / 51	50 / 52	51 / 53	49 / 51	50 / 52	51 / 53
	Sound power level (measured in anechoic room)			dB<A>	69 / 71	70 / 72	71 / 73	69 / 71	70 / 72	71 / 73
	Refrigerant piping diameter			Liquid pipe	9.52 flare					
				Gas pipe	15.88 flare					
	Fan	Type x Quantity		Propeller fan x 2						
		Airflow rate		m³/min	110					
				L/s	1,883					
cfm				3,884						
Motor output		kW	0.074 + 0.074							
Compressor	Type x Quantity		Scroll hermetic compressor x 1							
	Starting method		Inverter							
	Motor output		kW	2.9	3.5	3.9	2.9	3.5	3.9	
External dimensions (H x W x D)			mm	1,338 x 1,050 x 330 (+40)						
Weight			kg	123			YKM: 125 / YKME: 136			

*1

	Indoor	Outdoor	Piping length	Level difference
Cooling	27°C DB / 19°C WB	35°C DB	7.5m	0m
Heating	20°C DB	7°C DB / 6°C WB	7.5m	0m

*2 10 to 52°C D.B.: When connecting PKFY-P15/20/25VBM, PFFY-P20/25/32VKM, PFFY-P20/25/32VLE(R)M, PEFY-P*VMA3 or M, S and P series indoor unit.

*3 In the case of ATW single connection. Input to circulation pump is not included.

*4 In the case of simultaneous operation of ATA heating and ATW heating, target flow temperature range is restricted to 45-55°C and when the ambient temp is under 7°C, the flow temp is lowered.

*5 Up to P100 when connecting via branch box.

*6 Up to 11 units when connecting via 2 branch boxes.

*7 Only one ecodan unit can be connected.

*8 Exceptionally, one MSZ-SF15VA or MSZ-AP15VF can be connected.

*9 Exceptionally, two MSZ-SF15VA or MSZ-AP15VF can be connected.

*10 Exceptionally, three MSZ-SF15VA or MSZ-AP15VF can be connected.

*11 In the case of City Multi connection, maximum is P32.

*12 PKFY and PFFY series are not connectable.

Piping specifications

Total piping length	m	150*	a+b+c+d+e+f
Farthest piping length	m	80	a+b+d or a+c+e
		85	a+f
Total piping length between outdoor unit and branch box	m	55	a+b+c
Total piping length between branch boxes and indoor units	m	95	d+e
Farthest piping length from the first joint	m	30	b or c or f
Farthest piping length after branch box	m	25	d or e
Height difference (Outdoor upside / Outdoor downside)	m	50 / 40	

*When an ecodan is connected, the maximum piping length is 150m.

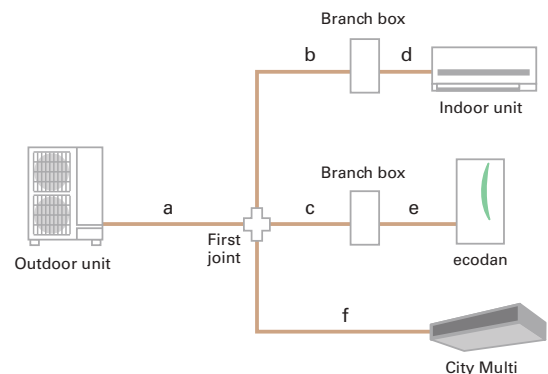

PUMY+ ecodan Compatibility Table

ATW branch box connection compatibility table

Series	Type	Model name	Compatibility	Type	Model name	Compatibility	Type	Model name	Compatibility
ATW	Cylinder unit	EHST20C-VM2/6D	●	Hydro box	EHSC-VM2/6D	●	Branch box	PAC-MK53BC	●
		EHST20C-YM9D	●		EHSC-YM9D	●		PAC-MK33BC	●

Connectable indoor unit capacity

For individual operation ATA+ATW (no simultaneous operation) ATA: Max 130% of outdoor unit capacity + ATW (EHST20C or EHSC)

Outdoor capacity 12.5kW		ATW indoor unit (Cylinder or Hydro box) 11.2kW	Connectable ATA indoor unit total capacity: Max.16.2kW (130%)
Outdoor capacity 14.0kW		ATW indoor unit (Cylinder or Hydro box) 11.2kW	Connectable ATA indoor unit total capacity: Max.18.2kW (130%)
Outdoor capacity 15.5kW		ATW indoor unit (Cylinder or Hydro box) 11.2kW	Connectable ATA indoor unit total capacity: Max.20.2kW (130%)

For simultaneous operation of ATA+ATW Max 100% of outdoor unit capacity: ATA + ATW (EHST20C or EHSC)

Outdoor capacity 12.5kW		ATW indoor unit (Cylinder or Hydro box) 11.2kW	ATA capacity Max. 1.3kW	*Exceptionally, one MSZ-SF15VA or MSZ-AP15VF can be connected.
Outdoor capacity 14.0kW		ATW indoor unit (Cylinder or Hydro box) 11.2kW	ATA capacity Max. 2.8kW	*Exceptionally, two units of MSZ-SF15VA or MSZ-AP15VF can be connected.
Outdoor capacity 15.5kW		ATW indoor unit (Cylinder or Hydro box) 11.2kW	ATA capacity Max. 4.3kW	*Exceptionally, three units of MSZ-SF15VA or MSZ-AP15VF can be connected.

Split Type Specifications

Indoor unit D generation for SUZ, PUD and PUHZ

<Cylinder unit (Heating only)>			Small capacity				
			EHST17D-VM2D	EHST20D-VM2D	EHST20D-YM9D	EHST30D-YM9ED	
Model name	Type	Heating only					
	Expansion vessel	✓	✓	✓	—		
	Booster heater (2/6/9 kW)	✓	✓	✓	✓		
Dimensions	HxWxD	mm	1400x595x680	1600x595x680	2050x595x680		
Weight (empty)		kg	93	99	102	117	
Control Board Power supply (Phase / V / Hz)			~ /N, 230V, 50Hz	~ /N, 230V, 50Hz	~ /N, 230V, 50Hz	~ /N, 230V, 50Hz	
Heater	Booster heater	Power supply (Phase / V / Hz)	~ /N, 230V, 50Hz	~ /N, 230V, 50Hz	3 ~ /N, 230V, 50Hz	3 ~ /N, 230V, 50Hz	
		Capacity	kW	2	2	3+6	3+6
		Current	A	9	9	13	13
		Breaker size	A	16	16	16	16
Domestic hot water tank	Volume / Material	L / -	170 / Stainless steel	200 / Stainless steel	300 / Stainless steel		
Guaranteed operating range *1	Ambient	°C	0 - 35 (≤80%RH)				
	Outdoor	Heating	°C	See outdoor unit spec table			
		Cooling	°C	—			
Target temperature range	Heating	Room temperature	°C				10 - 30
		Flow temperature	°C				20 - 60
	Cooling	Room temperature	°C				—
		Flow temperature	°C				—
DHW tank performance	Max. hot water temperature	°C	70				
	Water heater energy efficiency class		A+		A - A+		
Sound pressure level (PWL)		dB (A)	41				

*1 The indoor environment must be frost-free

*2 For the model without booster heater and immersion heater, the maximum allowable hot water temperature is 3°C lower than maximum outlet water of outdoor unit. For the maximum outlet water of outdoor unit, refer to outdoor unit data book.

<Cylinder unit (Heating only)>			Medium capacity					
			EHST20C-VM2D	EHST20C-VM6D	EHST20C-YM9D	EHST30C-VM6ED	EHST30C-YM9ED	
Model name	Type	Heating only						
	Expansion vessel	✓	✓	✓	—	—		
	Booster heater (2/6/9 kW)	✓	✓	✓	✓	✓		
Dimensions	HxWxD	mm	1600x595x680			2050x595x680		
Weight (empty)		kg	110	110	112	122	124	
Control Board Power supply (Phase / V / Hz)			~ /N, 230V, 50Hz	~ /N, 230V, 50Hz	~ /N, 230V, 50Hz	~ /N, 230V, 50Hz	~ /N, 230V, 50Hz	
Heater	Booster heater	Power supply (Phase / V / Hz)	~ /N, 230V, 50Hz	~ /N, 230V, 50Hz	3 ~ /N, 230V, 50Hz	~ /N, 230V, 50Hz	3 ~ /N, 230V, 50Hz	
		Capacity	kW	2	2+4	3+6	2+4	3+6
		Current	A	9	26	13	26	13
		Breaker size	A	16	32	16	32	16
Domestic hot water tank	Volume / Material	L / -	200 / Stainless steel			300 / Stainless steel		
Guaranteed operating range *1	Ambient	°C	0 - 35 (≤80%RH)					
	Outdoor	Heating	°C	See outdoor unit spec table				
		Cooling	°C	—				
Target temperature range	Heating	Room temperature	°C					10 - 30
		Flow temperature	°C					20 - 60
	Cooling	Room temperature	°C					—
		Flow temperature	°C					—
DHW tank performance	Max. hot water temperature	°C	70					
	Water heater energy efficiency class		A+			A		
Sound pressure level (PWL)		dB (A)	40					

*1 The indoor environment must be frost-free

*2 For the model without booster heater and immersion heater, the maximum allowable hot water temperature is 3°C lower than maximum outlet water of outdoor unit. For the maximum outlet water of outdoor unit, refer to outdoor unit data book.

<Hydro box (Heating only)>			Small capacity		Medium capacity			Large capacity	
			EHSD-VM2D	EHSD-YM9D	EHSC-VM2D	EHSC-VM6D	EHSC-YM9D	EHSE-YM9ED	
Model name	Type	Heating only							
	Expansion vessel	✓	✓	✓	✓	✓	—		
	Booster heater (2/6/9 kW)	✓	✓	✓	✓	✓	✓		
Dimensions	HxWxD	mm	800x530x360					950x600x360	
Weight (empty)		kg	43	44	47	48	48	63	
Control Board Power supply (Phase / V / Hz)			~ /N, 230V, 50Hz	~ /N, 230V, 50Hz	~ /N, 230V, 50Hz	~ /N, 230V, 50Hz	~ /N, 230V, 50Hz	~ /N, 230V, 50Hz	
Heater	Booster heater	Power supply (V / Phase / Hz)	~ /N, 230V, 50Hz	3 ~ /N, 230V, 50Hz	~ /N, 230V, 50Hz	~ /N, 230V, 50Hz	3 ~ /N, 230V, 50Hz	3 ~ /N, 230V, 50Hz	
		Capacity	kW	2	3+6	2	2+4	3+6	3+6
		Current	A	9	13	9	26	13	13
		Breaker size	A	16	16	16	32	16	16
Guaranteed operating range *1	Ambient	L / -	0 - 35 (≤80%RH)						
	Outdoor	Heating	°C	See outdoor unit spec table					
		Cooling	°C	—					
Target temperature range	Heating	Room temperature	°C						10 - 30
		Flow temperature	°C						20 - 60
	Cooling	Room temperature	°C						—
		Flow temperature	°C						—
Sound pressure level (PWL)		dB (A)	41	40			45		

*1 The indoor environment must be frost-free.

Split Type Specifications

Indoor unit D generation for SUZ, PUD and PUHZ

<Cylinder unit (Reversible)>			Small capacity			
			ERST17D-VM2D	ERST20D-VM2D	ERST30D-VM2ED	
Model name		Type	Heating and Cooling			
		Expansion vessel	✓	✓		
		Booster heater (2/6/9kW)	✓	✓	✓	
Dimensions	HxWxD	mm	1400x595x680	1600x595x680	2050x595x680	
Weight (empty)		kg	94	100	115	
Control Board Power supply (Phase / V / Hz)			~N, 230V, 50Hz	~N, 230V, 50Hz	~N, 230V, 50Hz	
Heater	Booster heater	Power supply (V / Phase / Hz)	~N, 230V, 50Hz	~N, 230V, 50Hz	~N, 230V, 50Hz	
		Capacity	kW	2	2	2
		Current	A	9	9	9
		Breaker size	A	16	16	16
Domestic hot water tank	Volume / Material	L / -	170 / Stainless steel	200 / Stainless steel	300 / Stainless steel	
Guaranteed operating range *1	Ambient	°C	0 - 35 (≤ 80%RH)			
	Outdoor	Heating	°C	See outdoor unit spec table		
		Cooling	°C	See outdoor unit spec table *2		
Target temperature range	Heating	Room temperature	°C 10 - 30			
		Flow temperature	°C 20 - 60			
	Cooling	Room temperature	°C -			
		Flow temperature	°C 5 - 25			
DHW tank performance	Max. hot water temperature	°C	70			
	Water heater energy efficiency class		A+		A - A+	
Sound pressure level (PWL)		dB (A)	41			

*1 The indoor environment must be frost-free.

*2 During cooling operation at low outdoor temperature (10°C or lower), frozen water may cause damage on plate heat exchanger.

<Cylinder unit (Reversible)>			Medium capacity		
			ERST20C-VM2D	ERST30C-VM2ED	
Model name		Type	Heating and Cooling		
		Expansion vessel	✓	✓	
		Booster heater (2/6/9kW)	✓	✓	
Dimensions	HxWxD	mm	1600x595x680	2050x595x680	
Weight (empty)		kg	110	122	
Control Board Power supply (Phase / V / Hz)			~N, 230V, 50Hz	~N, 230V, 50Hz	
Heater	Booster heater	Power supply (V / Phase / Hz)	~N, 230V, 50Hz	~N, 230V, 50Hz	
		Capacity	kW	2	2
		Current	A	9	9
		Breaker size	A	16	16
Domestic hot water tank	Volume / Material	L / -	200 / Stainless steel	300 / Stainless steel	
Guaranteed operating range *1	Ambient	°C	0 - 35 (≤ 80%RH)		
	Outdoor	Heating	°C See outdoor unit spec table		
		Cooling	°C See outdoor unit spec table *2		
Target temperature range	Heating	Room temperature	°C 10 - 30		
		Flow temperature	°C 20 - 60		
	Cooling	Room temperature	°C -		
		Flow temperature	°C 5 - 25		
DHW tank performance	Max. hot water temperature	°C	70		
	Water heater energy efficiency class		A+	A	
Sound pressure level (PWL)		dB (A)	40		

*1 The indoor environment must be frost-free.

*2 During cooling operation at low outdoor temperature (10°C or lower), frozen water may cause damage on plate heat exchanger.

<Hydro box (Reversible)>			Small capacity	Medium capacity	Large capacity		
			ERSD-VM2D	ERSC-VM2D	ERSE-MED	ERSE-VM9ED	
Model name		Type	Heating and Cooling				
		Expansion vessel	✓	✓	-	-	
		Booster heater (2/6/9kW)	✓	✓	-	✓	
Dimensions	HxWxD	mm	800x530x360		950x600x360		
Weight (empty)		kg	44	48	62	64	
Control Board Power supply (Phase / V / Hz)			~N, 230V, 50Hz	~N, 230V, 50Hz	~N, 230V, 50Hz	~N, 230V, 50Hz	
Heater	Booster heater	Power supply (V / Phase / Hz)	~N, 230V, 50Hz	~N, 230V, 50Hz	-	3~400V, 50Hz	
		Capacity	kW	2	2	-	3+6
		Current	A	9	9	-	13
		Breaker size	A	16	16	-	16
Guaranteed operating range *1	Ambient	°C	0 - 35 (≤ 80%RH)				
	Outdoor	Heating	°C See outdoor unit spec table				
		Cooling	°C See outdoor unit spec table *2				
Target temperature range	Heating	Room temperature	°C 10 - 30				
		Flow temperature	°C 20 - 60				
	Cooling	Room temperature	°C -				
		Flow temperature	°C 5 - 25				
Sound pressure level (PWL)		dB (A)	41	40	45		

*1 The indoor environment must be frost-free.

*2 If you use our system in cooling mode at the low ambient temperature (10°C or below), there are some risks of plate heat exchanger breaking by frozen water.

Split Type Specifications

Outdoor unit

				Eco Inverter							
				Standard model				Hyper Heating model		Standard with base heater model	
Model name				SUZ-SWM40VA2	SUZ-SWM60VA2	SUZ-SWM80VA2	SUZ-SWM100VA	SUZ-SHWM40VAH	SUZ-SHWM60VAH	SUZ-SWM80VAH2	SUZ-SWM100VAH
Refrigerant				R32*1							
Dimensions		HxWxD	mm	714x800x285	714x800x285	880x840x330	880x840x330	714x800x285	880x840x330	880x840x330	880x840x330
Weight			kg	39	40	53	53	40	53.5	53.5	53.5
Power supply (V / Phase / Hz)				230 / 1-ph / 50							
Heating	A7W35*2	Nominal	kW	3.0	5.0	6.0	7.5	3.0	5.0	6.0	7.5
		COP		5.11	4.85	5.10	4.85	4.77	4.95	5.10	4.85
	A2W35*2	Nominal	kW	4.0	6.0	7.5	9.0	4.0	6.0	7.5	9.0
		COP		3.90	3.62	3.50	3.12	3.61	3.47	3.31	3.00
Average climate water outlet 35°C*3		Class		A+++	A+++	A+++	A+++	A+++	A+++	A+++	A+++
		ηs		200%	189%	187%	182%	176%	178%	178%	177%
Average climate water outlet 55°C*3		Class		A++	A++	A++	A++	A++	A++	A++	A++
		ηs		135%	136%	135%	134%	126%	128%	130%	129%
DHW 200L Load Profile*4		Class		A+	A+	A+	A+	A+	A+	A+	A+
		ηwh		147%	142%	142%	142%	144%	144%	142%	142%
Max outlet water temperature			°C	60	60	60	60	60	60	60	60
Cooling	A35W7*2	Nominal	kW	4.5	5.0	6.7	7.3	4.5	6.0	6.7	7.3
		EER		3.31	3.18	3.20	3.00	3.33	3.28	3.20	3.00
	A35W18*2	Nominal	kW	5.6	6.0	6.7	8.1	5.6	6.0	6.7	8.1
		EER		4.71	4.65	5.06	4.44	4.70	5.21	5.06	4.44
PWL (Heating)*5			dB(A)	57	60	60	62	58	60	60	62
Max operating current			A	13.5	13.5	17.3	17.3	13.5	17.3	17.3	17.3
Breaker size			A	16	16	20/16*6	20/16*6	16	20/16*6	20/16*6	20/16*6
Piping	Diameter	Liquid/Gas	mm	6.35/12.7	6.35/12.7	6.35/12.7	6.35/12.7	6.35/12.7	6.35/12.7	6.35/12.7	6.35/12.7
	Length	Out-In	m	2-26	2-26	2-46	2-46	2-26	2-46	2-46	2-46
	Height	Out-In	m	Max. 26	Max. 26	Max. 30	Max. 30	Max. 26	Max. 30	Max. 30	Max. 30
Guaranteed Operating Range	Heating	°C		-25°C~24°C	-25°C~24°C	-25°C~24°C	-25°C~24°C	-25°C~24°C	-25°C~24°C	-25°C~24°C	-25°C~24°C
	DHW	°C		-25°C~35°C	-25°C~35°C	-25°C~35°C	-25°C~35°C	-25°C~35°C	-25°C~35°C	-25°C~35°C	-25°C~35°C
	Cooling	°C		10°C~46°C	10°C~46°C	10°C~46°C	10°C~46°C	10°C~46°C	10°C~46°C	10°C~46°C	10°C~46°C

				Power Inverter, Heating only			ZUBADAN, Heating only				
				PUD-SWM80V/YAA	PUD-SWM100V/YAA	PUD-SWM120V/YAA	PUD-SHWM80V/YAA	PUD-SHWM100V/YAA	PUD-SHWM120V/YAA	PUD-SHWM140V/YAA	
Model name				R32*1							
Refrigerant				R32*1							
Dimensions		HxWxD	mm	1020x1050x480	1020x1050x480	1020x1050x480	1020x1050x480	1020x1050x480	1020x1050x480	1020x1050x480	1020x1050x480
Weight			kg	101/114	105/118	105/118	102/115	108/121	108/121	110/122	110/122
Power supply (V / Phase / Hz)				VAA: 230 / 1-ph / 50, YAA: 400 / 3-ph / 50							
Heating	A7W35*2	Nominal	kW	6.0	8.0	10.0	6.0	8.0	10.0	12.0	
		COP		4.76	5.00	4.70	5.03	5.00	4.80	4.70	
	A2W35*2	Nominal	kW	8.0	10.0	12.0	8.0	10.0	12.0	14.0	
		COP		3.55	3.30	3.24	3.75	3.45	3.30	3.05	
Average climate water outlet 35°C*3		Class		A+++	A+++	A+++	A+++	A+++	A+++	A+++	
		ηs		178%/176%	178%/177%	177%/176%	181%/179%	180%/178%	179%/177%	179%/177%	
Average climate water outlet 55°C*3		Class		A++	A++	A++	A++	A++	A++	A++	
		ηs		131%/130%	131%/130%	129%/128%	135%/134%	136%/135%	135%/134%	134%/134%	
DHW 200L(L) Load Profile (Average climate)*4		Class		A+ / A	A+ / A	A+ / A	A+ / A	A+ / A	A+ / A	A+ / A	
		ηwh		141%	141%	141%	141%	141%	141%	136%	
Max outlet water temperature			°C	60	60	60	60	60	60	60	
PWL (Heating)*5			dB(A)	56	59	60	56	59	60	62	
Max operating current			A	22/8	26/10	28/12	22/8	26/10	28/12	35/12	
Breaker size			A	25/16	30/16	32/16	25/16	30/16	32/16	40/16	
Piping	Diameter	Liquid/Gas	mm	6.35/12.7	6.35/12.7	6.35/12.7	6.35/12.7	6.35/12.7	6.35/12.7	6.35/12.7	
	Length	Out-In	m	2 - 30	2 - 30	2 - 30	2 - 30	2 - 30	2 - 30	2 - 25	
	Height	Out-In	m	Max. 30	Max. 30	Max. 30	Max. 30	Max. 30	Max. 30	Max. 25	
Guaranteed Operating Range	Heating	°C		-25°C~24°C	-25°C~24°C	-25°C~24°C	-28°C~24°C	-28°C~24°C	-28°C~24°C	-28°C~24°C	
	DHW	°C		-25°C~35°C	-25°C~35°C	-25°C~35°C	-28°C~35°C	-28°C~35°C	-28°C~35°C	-28°C~35°C	

*1 Refrigerant leakage contribute to climate change. Refrigerant with lower global warming potential (GWP) would contribute less to global warming than a refrigerant with higher GWP, if leaked to the atmosphere. This appliance contains a refrigerant fluid with a GWP equal to 550. This means that if 1 kg of this refrigerant fluid would be leaked to the atmosphere, the impact on global warming would be 550 times higher than 1 kg of CO₂, over a period of 100 years. Never try to interfere with the refrigerant circuit yourself or disassemble the product yourself and always ask a professional. The GWP of R32 is 675 in the IPCC 4th Assessment Report.

*2 Air-to-Water values are measured based on EN14511 (Circulation pump input is not included.). *3 ηs values are measured based on EN14825.

*4 ηwh values are measured based on EN16147. *5 Sound power levels are measured based on EN12102. *6 In case of jumper wire cut.

R32	Split type	Small capacity (Under 5kW)*	Medium capacity (6.0kW-14kW)*
			 
			 
	Eco Inverter	 	 

*Rated capacity is at conditions A2W35. (according to EN14511)
*SUZ rated capacity is at conditions A7W35.

R410A

Split Type Specifications

Outdoor unit



Model name				Power Inverter			
				PUHZ-SW160YKA(-BS)		R410A*1	
Refrigerant				R410A*1			
Dimensions		HxWxD	mm	1338x1050x330		1338x1050x330	
Weight		kg		136		136	
Power supply (V / Phase / Hz)				VAA, VHA: 230 / 1-ph / 50, YAA, YHA, YKA: 400 / 3-ph / 50			
Heating	A7W35*2	Nominal		kW		22.0	
		COP				4.20	
	A2W35*2	Nominal		kW		16.0	
		COP				3.11	
Average climate water outlet 35°C*3		Class		A++		A++	
		ηs		161		163	
Average climate water outlet 55°C*3		Class		A++		A++	
		ηs		125		127	
DHW 200(L)/300(L)(XL) Load Profile (Average climate)*4		Class		-		-	
		ηwh		-		-	
Max outlet water temperature (°C)				-			
Cooling	A35W7*2	Nominal		kW		16.0	
		EER				2.76	
	A35W18*2	Nominal		kW		18.0	
		EER				4.56	
PWL (Heating)*5		dB(A)		78		78	
Max operating current		A		19.0		21.0	
Breaker size		A		25		32	
Piping	Diameter	Liquid/Gas	mm	9.52/25.4		12.7/25.4	
	Length	Out-In	m	80		80	
	Height	Out-In	m	30		30	
Guaranteed Operating Range	Heating		°C	-20°C-21°C		-20°C-21°C	
	DHW		°C	-20°C-35°C		-20°C-35°C	
	Cooling		°C	-15°C-46°C		-15°C-46°C	

Model name				ZUBADAN			
				PUHZ-SHW230YKA2		R410A*1	
Refrigerant				R410A*1			
Dimensions		HxWxD	mm	1338x1050x330			
Weight		kg		143			
Power supply (V / Phase / Hz)				VAA, VHA: 230 / 1-ph / 50, YAA, YHA, YKA: 400 / 3-ph / 50			
Heating	A7W35*2	Nominal		kW		23.0	
		COP				3.65	
	A2W35*2	Nominal		kW		23.0	
		COP				2.37	
Average climate water outlet 35°C*3		Class		A++		A++	
		ηs		164		164	
Average climate water outlet 55°C*3		Class		A++		A++	
		ηs		127		127	
DHW 200(L)/300(L)(XL) Load Profile (Average climate)*4		Class		-		-	
		ηwh		-		-	
Max outlet water temperature (°C)				60			
Cooling	A35W7*2	Nominal		kW		20.0	
		EER				2.22	
	A35W18*2	Nominal		kW		20.0	
		EER				3.55	
PWL (Heating)*5		dB(A)		75		75	
Max operating current		A		20		20	
Breaker size		A		25		25	
Piping	Diameter	Liquid/Gas	mm	12.7/25.4			
	Length	Out-In	m	80			
	Height	Out-In	m	30			
Guaranteed Operating Range	Heating		°C	-25°C-21°C			
	DHW		°C	-25°C-35°C			
	Cooling		°C	-15°C-46°C			

*1 Refrigerant leakage contribute to climate change. Refrigerant with lower global warming potential (GWP) would contribute less to global warming than a refrigerant with higher GWP, if leaked to the atmosphere. This appliance contains a refrigerant fluid with a GWP equal to 550. This means that if 1 kg of this refrigerant fluid would be leaked to the atmosphere, the impact on global warming would be 550 times higher than 1 kg of CO₂, over a period of 100 years. Never try to interfere with the refrigerant circuit yourself or disassemble the product yourself and always ask a professional. The GWP of R410A is 2088 in the IPCC 4th Assessment Report.

*2 Air-to-Water values are measured based on EN14511 (Circulation pump input is not included.).

*3 ηs values are measured based on EN14825. *4 ηwh values are measured based on EN16147. *5 Sound power levels are measured based on EN12102.

R410A	Split type	Large capacity (≥16kW)
		PUHZ-SHW230
		PUHZ-SW160/200

Split Model Specification

Indoor unit E generation for PUZ

<Cylinder unit>

Model name		ERST20F-VM2E	ERST20F-YM9E	ERST30F-VM2EE	ERST30F-YM9EE
Type		Heating and cooling			
Expansion vessel		3	3	-	-
Booster heater		3	3	3	3
Dimensions	HxWxD	1600 x 595 x 680		2050 x 595 x 680	
Weight (empty)	kg	94	98	109	112
Control board power supply (Phase / V / Hz)		~N, 230 V, 50 Hz			
Heater	Booster heater	Power supply (Phase / V / Hz)		~N, 230 V, 50 Hz	3~, 400V, 50 Hz
		Capacity	kW	2	3+6
		Current	A	9	13
		Breaker	A	16	16
Domestic hot water tank	Volume	L	200	300	
Guaranteed operating range *1	Indoor unit ambient	°C	0~35 (≤80%RH)		
	Outdoor	Heating	°C	See outdoor unit spec table.	
		Cooling	°C	See outdoor unit spec table.*2	
Target temperature range	Heating	Room temperature	°C	10~30	
		Flow temperature *4	°C	20~70	
	Cooling	Room temperature	°C	--	
		Flow temperature	°C	5~25	
DHW tank performance	Max. hot water temperature	°C	70		
	Water heating energy efficiency class		Depending on outdoor unit.		
Sound power level (PWL)		dB(A)	41		

*1 The environment must be frost-free.

*2 During cooling operation at low outdoor temperature (10°C or lower), frozen water may cause damage on plate heat exchanger.

*3 For the model without booster heater and immersion heater, the maximum allowable hot water temperature is 3°C lower than maximum outlet water of outdoor unit. For the maximum outlet water of outdoor unit, refer to outdoor unit data book.

*4 Max temperature is depending on the connected outdoor unit.

<Hydrobox>

Model name		ERSF-VM2E	ERSF-YM9E		
Type		Heating and cooling			
Expansion vessel		3	3		
Booster heater		3	3		
Dimensions	HxWxD	800 x 530 x 360			
Weight (empty)	kg	29	31		
Control board power supply (Phase / V / Hz)		~N, 230, 50 Hz			
Heater	Booster heater	Power supply (Phase / V / Hz)		~N, 230, 50 Hz	3~, 400, 50 Hz
		Capacity	kW	2	3+6
		Current	A	9	13
		Breaker	A	16	16
Guaranteed operating range *1	Indoor unit ambient	°C	0~35°C (≤80%RH)		
	Outdoor	Heating	°C	See outdoor unit spec table.	
		Cooling	°C	See outdoor unit spec table.*2	
Target temperature range	Heating	Room temperature	°C	10~30	
		Flow temperature *3	°C	20~75	
	Cooling	Room temperature	°C	-	
		Flow temperature	°C	-	
Sound power level (PWL)		dB(A)	41		

*1 The environment must be frost-free.

*2 During cooling operation at low outdoor temperature (10°C or lower), frozen water may cause damage on plate heat exchanger.

*3 Max temperature is depending on the connected outdoor unit."

Split Type Specifications

				Power Inverter				ZUBADAN			
Model name				PUZ-SWM80V/YAA	PUZ-SWM100V/YAA	PUZ-SWM120V/YAA	PUZ-SWM140V/YAA	PUZ-SHWM80V/YAA	PUZ-SHWM100V/YAA	PUZ-SHWM120V/YAA	PUZ-SHWM140V/YAA
Refrigerant mm				R32*1							
Dimensions		HxWxD	kg	1040x1050x480							
Weight				104.5/113.5	105.5/113.5	112/124.5	113.5/124.5	106/115	106.5/115	113.5/125.5	114.5/126
Power supply (V / Phase / Hz)			kW	VAA: 230 / 1-ph / 50, YAA: 400 / 3-ph / 50							
Heating	A7W35*2	Nominal		6.00	8.00	10.00	12.00	6.00	8.00	10.00	12.00
		COP		5,02	5,02	4,87	4,85	5,05	5,05	4,90	4,85
	A2W35*2	Nominal		8.00	10.00	12,1	14.00	8.00	10.00	12,1	14.00
		COP		3,70	3,47	3,27	3,21	3,8	3,55	3,35	3,30
Average climate water outlet 35°C*3		Class		A+++	A+++	A+++	A+++	A+++	A+++	A+++	A+++
		ηs		184%/184%	181%/180%	179%/179%	178%/177%	188%/187%	186%/186%	182%/182%	185%/185%
Average climate water outlet 55°C*3		Class		A++	A++	A++	A++	A++	A++	A++	A++
		ηs		130%/130%	134%/134%	133%/132%	136%/135%	134%/133%	138%/138%	138%/138%	142%/142%
DHW 200(L) Load Profile (Average climate)*4		Class		A+	A+	A+	A+	A+	A+	A+	A+
		ηwh		137%	137%	137%	131%	137%	137%	137%	131%
Max outlet water temperature			°C	68				70*8			
Cooling	A35W7*2	Nominal	kW	7.10	9.00	11,0	12.50	7.10	9.00	11,0	12.50
		EER		3,30	3,00	2,86	2,62	3,30	3,00	2,86	2,62
	A35W18*2	Nominal	kW	8.00	10,00	12.00	14.00	8.00	10,00	12.00	14.00
		EER		4,95	4,50	4,50	3,75	4,95	4,50	4,50	3,75
PWL (Heating)*5			dB(A)	54	58	58	58	54	58	58	58
Max operating current			A	17 / 8	22 / 9	28 / 12	28 / 12	19 / 8	27 / 9	28 / 12	35 / 12
Breaker size			A	20/16	25/16	32/16	32/16	25/16	30/16	32/16	40/16
Piping	Diameter	Gas	mm	ø12.7 (15.88)*6				ø12.7 (15.88)*6			
		Liquid	mm	6.35				6.35			
	Length	Out-In	m	50	50	30*7	30*7	50	50	30*7	30*7
	Height	Out-In	m	30				30			
Guaranteed operation range	Cooling	°C		10°C~52°C				10°C~52°C			
	Heating	°C		-25°C ~24°C				-30°C~24°C			
	DHW	°C		-25°C ~42°C				-30°C ~42°C			

*1 Refrigerant leakage contribute to climate change. Refrigerant with lower global warming potential (GWP) would contribute less to global warming than a refrigerant with higher GWP, if leaked to the atmosphere. This appliance contains a refrigerant fluid with a GWP equal to 550. This means that if 1 kg of this refrigerant fluid would be leaked to the atmosphere, the impact on global warming would be 550 times higher than 1 kg of CO₂, over a period of 100 years. Never try to interfere with the refrigerant circuit yourself or disassemble the product yourself and always ask a professional. The GWP of R32 is 675 in the IPCC 4th Assessment Report.

*2 Air-to-Water values are measured based on EN14511 (Circulation pump input is not included).

*3 ηs values are measured based on EN14825.

*4 ηwh values are measured based on EN16147.

*5 Sound power levels are measured based on EN12102.

*6 A diameter of 15.88 is necessary for cooling operation. Please refer to our installation manual for details.

*7 Maximum piping length can be up to 50m for heating only operation.

*8 With Delta T = 10°C

Packaged Type Specifications

<Cylinder unit (Reversible)>

Model name		ERPT17X-VM2D	ERPT20X-VM2D	ERPT30X-VM2ED		
Type		Heating and cooling				
Immersion heater		-	-	-		
Expansion vessel		✓	✓	-		
Booster heater		✓	✓	✓		
Dimensions	HxWxD	mm	1400x595x680	1600x595x680	2050x595x680	
Weight (empty)		kg	86	94	107	
Control board power supply (Phase / V / Hz)			~N, 230V, 50Hz			
Heater	Booster heater	Power supply (Phase / V / Hz)	~N, 230V, 50Hz	~N, 230V, 50Hz		
		Capacity	kW	2	2	2
		Current	A	9	9	9
		Breaker size	A	16	16	16
	Immersion heater*2	Power supply (Phase / V / Hz)	-	-	-	
		Capacity	kW	-	-	-
		Current	A	-	-	-
		Breaker size	A	-	-	-
Domestic hot water tank	Volume / Material	L / -	170 / Stainless steel	200 / Stainless steel	300 / Stainless steel	
Guaranteed operating range*1	Ambient	°C	0 - 35 (≤80%RH)			
	Outdoor	Heating	°C	See outdoor unit spec table		
		Cooling	°C	See outdoor unit spec table*4		
Target temperature range	Heating	Room temperature	°C	10-30		
		Flow temperature	°C	20-60		
	Cooling	Room temperature	°C	-		
		Flow temperature	°C	5-25		
DHW tank performance	Max. hot water temperature	°C	70			
	Water heater energy efficiency class		A+		A	
Sound pressure level (PWL)		dB (A)	40			

*1 The indoor environment must be frost-free.

*2 Do not fit immersion heaters without thermal cut-out. Use only Mitsubishi Electric service parts as a direct replacement.

*3 For the model without booster heater and immersion heater, the maximum allowable hot water temperature is 3°C lower than maximum outlet water of outdoor unit.

For the maximum outlet water of outdoor unit, refer to outdoor unit data book.

*4 During cooling operation at low outdoor temperature (10°C or lower), frozen water may cause damage on plate heat exchanger.





Packaged Type Specifications



<Hydro box (Reversible)>

Model name		ERPX-VM2D		
Type		Heating and cooling		
Immersion heater		-		
Expansion vessel		✓		
Booster heater		✓		
Dimensions	HxWxD	mm	800x530x360	
Weight (empty)		kg	33	
Control board power supply (Phase / V / Hz)		~N, 230V, 50Hz		
Heater	Booster heater	Power supply (Phase / V / Hz)		
		~N, 230V, 50Hz		
		Capacity	kW	
		Current	A	
Breaker size		A	16	
Guaranteed operating range*1	Ambient	°C	0-35 (≤80%RH)	
	Outdoor	Heating	°C	See outdoor unit spec table
		Cooling	°C	See outdoor unit spec table *2
Target temperature range	Heating	Room temperature	°C	10-30
		Flow temperature	°C	20-60
	Cooling	Room temperature	°C	-
		Flow temperature	°C	-
Sound pressure level (PWL)		dB (A)	40	

*1 The indoor environment must be frost-free.
 *2 If you use our system in cooling mode at the low ambient temperature (10°C or below), there are some risks of plate heat exchanger breaking by frozen water.

Packaged type	Small capacity (Under 5kW)*	Medium capacity (6.0kW-14kW)*
		
		PUZ-HWM140

*Rated capacity is at conditions A2W35. (according to EN14511)

Packaged type	Small capacity (Under 5kW)*	Medium capacity (8.0kW-11.2kW)*
		
	PUZ-WM50	PUZ-WM85/112

*Rated capacity is at conditions A2W35. (according to EN14511)

Outdoor unit

Model name		PUZ-WM50VHA		PUZ-WM85V/YAA		PUZ-WM112V/YAA		PUZ-HWM140V/YHA	
Refrigerant		R32*1							
Dimensions		HxWxD	mm	943x950x330	1020x1050x480	1020x1050x480	1350x1020x330		
Weight			kg	71	98/111	119/132	132/143		
Power supply (V / Phase / Hz)		VHA • VAA: 230 / 1-ph / 50, YHA • YAA: 400 / 3-ph / 50							
Heating	A7W35*2	Nominal	kW	5.0	8.5	11.2	14.0		
		COP		5.00	4.80	4.70	4.46		
	A2W35*2	Nominal	kW	5.0	8.5	11.2	14.0		
		COP		3.70	3.51	3.44	3.15		
Average climate water outlet 35°C*3	Class			A+++	A+++	A+++	A+++		
		ηs		190	197	195	178/177		
Average climate water outlet 55°C*3	Class			A++	A++	A++	A++		
		ηs		133	141	136	133		
DHW 200(L) Load Profile (Average climate)*4	Class			A+	A+	A+	A+		
		ηwh		135	141	138	124		
Max outlet water temperature (°C)				60	60	60	60		
Cooling	A35W7*2	Nominal	kW	4.5	7.5	10.0	11.9		
		EER		3.40	3.15	3.30	3.00		
	A35W18*2	Nominal	kW	4.5	7.5	10.0	11.1		
		EER		5.00	4.90	4.90	4.10		
PWL (Heating)*5		dB(A)		61	58	60	67		
Max operating current		A		13.0	22.0/11.5	28.0/13.0	35.0/13.0		
Breaker size		A		16	25/16	32/16	40/16		
Piping	Diameter	Liquid/Gas	mm	-	-	-	-		
	Length	Out-In	m	-	-	-	-		
	Height	Out-In	m	-	-	-	-		
Guaranteed Operating Range	Heating	°C	-20°C-21°C	-20°C-21°C	-25°C-21°C	-28°C-21°C			
	DHW	°C	-20°C-35°C	-20°C-35°C	-25°C-35°C	-28°C-35°C			
	Cooling	°C	10°C-46°C	10°C-46°C	10°C-46°C	10°C-46°C			

*1 Refrigerant leakage contribute to climate change. Refrigerant with lower global warming potential (GWP) would contribute less to global warming than a refrigerant with higher GWP, if leaked to the atmosphere. This appliance contains a refrigerant fluid with a GWP equal to 550. This means that if 1 kg of this refrigerant fluid would be leaked to the atmosphere, the impact on global warming would be 550 times higher than 1 kg of CO₂, over a period of 100 years. Never try to interfere with the refrigerant circuit yourself or disassemble the product yourself and always ask a professional. The GWP of R32 is 675 in the IPCC 4th Assessment Report.

*2 Air-to-Water values are measured based on EN14511 (Circulation pump input is not included.).

*3 ηs values are measured based on EN14825.

*4 ηwh values are measured based on EN16147.

*5 Sound power levels are measured based on EN12102.

Optional Parts

Split type

<Indoor unit>

Parts name	Model name	Cylinder	Hydrobox	Remarks
Wireless remote controller	PAR-WT50R-E	✓	✓	
Wireless receiver	PAR-WR51R-E	✓	✓	
Thermistors	PAC-SE41TS-E	✓	✓	For room temp.
	PAC-TH011-E	✓	✓	For buffer and zone (flow and return temp.)
	PAC-TH011TK2-E	-	✓	For tank temp. (5m)
	PAC-TH012HT-E	✓	✓	For boiler and buffer (5m)
Immersion heater	PAC-IH01V2-E	✓	-	1Ph 1kW
	PAC-IH03V2-E	✓	-	1Ph 3kW
Wi-Fi interface	MAC-567IF-E	✓	✓	
2 Zone kit	PAC-TZ02-E	✓	✓	

<Outdoor unit>

Parts name	Model name	R32 (Eco Inverter)			R32 Heating only (Power Inverter)			R32 Heating only (ZUBADAN)			
		SUZ-SWM40VA	SUZ-SWM60VA	SUZ-SWM80VA	PUD-SWM80VYAA	PUD-SWM100VYAA	PUD-SWM120VYAA	PUD-SHM80VYAA	PUD-SHM100VYAA	PUD-SHM120VYAA	PUD-SHM140VYAA
Connector for drain hose heater signal output	PAC-SE60RA-E	-	-	-	✓	✓	✓	✓	✓	✓	✓
Air discharge guide	MAC-886SG-E	✓	✓	✓	-	-	-	-	-	-	-
	PAC-SG59SG-E	-	-	-	-	-	-	-	-	-	-
	PAC-SH96SG-E*1	-	-	-	✓*1	✓*1	✓*1	✓*1	✓*1	✓*1	✓*1
Air protection guide	PAC-SH63AG-E	-	-	-	-	-	-	-	-	-	-
	PAC-SH95AG-E*1	-	-	-	✓*1	✓*1	✓*1	✓*1	✓*1	✓*1	✓*1
Attachement	PAC-SJ82AT-E	-	-	-	✓	✓	✓	✓	✓	✓	✓
Drain socket*2	PAC-SG61DS-E	-	-	-	✓	✓	✓	✓	✓	✓	✓
Centralized drain pan*2	PAC-SG64DP-E	-	-	-	-	-	-	-	-	-	-
	PAC-SH97DP-E	-	-	-	-	-	-	-	-	-	-
	PAC-SJ83DP-E	-	-	-	✓	✓	✓	✓	✓	✓	✓
Base heater	MAC-642BH-U1	✓	✓	✓	-	-	-	-	-	-	-
Control/Service tool	PAC-SK52ST	-	-	-	✓	✓	✓	✓	✓	✓	✓

*1 Attachment (PAC-SJ82AT-E) is necessary for the Air guide

*2 Cannot be used for cold climate.

Parts name	Model name	R410A (Power Inverter)					R410A (ZUBADAN)			
		PUHZ-SW75VYAA	PUHZ-SW100VYAA	PUHZ-SW120VYAA	PUHZ-SW160VYAA	PUHZ-SW200VYAA	PUHZ-SHW80VYAA	PUHZ-SHW112VYAA	PUHZ-SHW140VYAA	PUHZ-SHW230VYAA
Connector for drain hose heater signal output	PAC-SE60RA-E	✓	✓	✓	✓	✓	✓	✓	✓	✓
Air discharge guide	MAC-886SG-E	-	-	-	-	-	-	-	-	-
	PAC-SG59SG-E	-	-	✓	-	-	-	-	✓	-
	PAC-SH96SG-E	✓	✓	✓	✓	✓	✓	✓	-	✓
Air protection guide	PAC-SH63AG-E	-	-	✓	-	-	-	-	✓	-
	PAC-SH95AG-E	✓	✓	-	✓	✓	✓	✓	-	✓
Attachement	PAC-SJ82AT-E	✓	✓	-	-	-	✓	✓	-	✓
Drain socket*2	PAC-SG61DS-E	✓	✓	✓	✓	✓	✓	✓	-	-
Centralized drain pan*2	PAC-SG64DP-E	-	-	✓	-	-	-	-	-	-
	PAC-SH97DP-E	-	-	-	✓	✓	-	-	-	-
	PAC-SJ83DP-E	✓	✓	-	-	-	✓	✓	-	-
Base heater	MAC-642BH-U1	-	-	-	-	-	-	-	-	-
Control/Service tool	PAC-SK52ST	✓	✓	✓	✓	✓	✓	✓	✓	✓

*1 Attachment (PAC-SJ82AT-E) is necessary for the Air guide

*2 Cannot be used for cold climate.

Split model E-generation

Parts name	Model name	Cylinder	Hydrobox	Remarks
Wireless remote controller	PAR-WT60R-E	✓	✓	
Wireless receiver	PAR-WR61R-E	✓	✓	
Thermistors	PAC-SE41TS-E	✓	✓	For room temp.
	PAC-TH011-E	✓	✓	For buffer and zone (flow and return temp.)
	PAC-TH011TK2-E	---	✓	For tank temp. (5 m)
	PAC-TH011TKL2-E	---	✓	For tank temp. (30 m)
	PAC-TH012HT-E	✓	✓	For boiler and buffer(5 m)
	PAC-TH012HTL-E	✓	✓	For boiler and buffer(30 m)
Immersion heater	PAC-IH01V2-E	✓	---	1Ph 1kW
	PAC-IH03V2-E	✓	---	1Ph 3kW
Wi-Fi interface	MAC-587IF-E	✓	✓	
2 zone kit	PAC-TZ02-E2	✓	✓	

Interface/Flow Temperature Controller

Split type

Parts name	Model name	Description
Capacity step control interface	PAC-IF011B-E	1 PC board w/ Case
Flow temperature controller	PAC-IF032B-E	1 PC board w/ Case
	PAC-IF033B-E	1 PC board w/ Case
	PAC-IF033PCB-E	10 PC board w/o case
System Controllers	PAC-IF071B-E	1 PC board w/ Case
Pressure sensor	PAC-PS01-E	For SUZ-SWM40/60/80VA
Flow sensor	PAC-FS01-E	
Thermistor	PAC-TH011-E	

Optional Parts

Packaged type

<Indoor unit>

Parts name	Model name	Cylinder	Hydrobox	Remarks
Wireless remote controller	PAR-WT50R-E	✓	✓	
Wireless receiver	PAR-WR51R-E	✓	✓	
Thermistors	PAC-SE41TS-E	✓	✓	For room temp.
	PAC-TH011-E	✓	✓	For buffer and zone (flow and return temp.)
	PAC-TH011TK2-E	-	✓	For tank temp. (5m)
	PAC-TH012HT-E	✓	✓	For boiler and buffer (5m)
Immersion heater	PAC-IH01V2-E	✓ (Except EHPT20X-MHEDW)	-	1Ph 1kW
	PAC-IH03V2-E	✓ (Except EHPT20X-MHEDW)	-	1Ph 3kW
Wi-Fi interface	MAC-5671F-E	✓	✓	
2 Zone kit	PAC-TZ02-E	✓	✓	

<Outdoor unit>

Parts name	Model name	R32 (Power Inverter)			
		PUZ-WM50VHA	PUZ-WM85V/YAA	PUZ-WM112V/YAA	PUZ-HWM140V/YHA
Connector for drain hose heater signal output	PAC-SE60RA-E	✓	✓	✓	✓
Air discharge guide	PAC-SG59SG-E	✓	-	-	✓
	PAC-SH96SG-E	-	✓*	✓*	-
Air protection guide	PAC-SH63AG-E	✓	-	-	✓
	PAC-SH95AG-E	-	✓*	✓*	-
Attachement	PAC-SJ82AT-E	-	✓	✓	-
Drain socket	PAC-SG61DS-E	✓	✓	✓	-
Centralized drain pan	PAC-SG64DP-E	✓	-	-	-
	PAC-SJ83DP-E	-	✓	✓	-

*Attachment (PAC-SJ82AT-E) is necessary for the Air Guide.

Interface/Flow Temperature Controller

Packaged type

Parts name	Model name	Description
Flow temperature controller	PAC-IF033B-E	1 PC board w/ Case
	PAC-IF033PCB-E	10 PC board w/o case
System Controllers	PAC-IF072B-E	
Flow sensor	PAC-FS01-E	
Thermistor	PAC-TH011-E	



MELCloud (Wi-Fi Interface) for ecodan

MELCloud for Fast, Easy Remote Control and Monitoring of Your ecodan

MELCloud is a new Cloud-based solution for controlling ecodan either locally or remotely by computer, tablet or smartphone via the Internet. Setting up and remotely operating your ecodan heating system via MELCloud is simple and straight forward. All you need is wireless computer connectivity in your home or the building where the ecodan is installed and an Internet connection on your mobile or fixed terminal. To set up the system, the router and the ecodan WiFi interface must be paired, and this is done simply and quickly using the WPS button found on all mainstream routers.

You can control and check ecodan via MELCloud from virtually anywhere an Internet connection is available. That means, thanks to MELCloud, you can use ecodan much more easily and conveniently.



Key Control and Monitoring Features

- 1 Turn system on/off**
- 2 See status of each of your heating zones & adjust set points**
- 3 See the status of your hot water cylinder & boost remotely**
- 4 Live weather feed from ecodan location**
 - Holiday mode - Set system parameters while away
 - Schedule timer - Set 7 day weekly schedule
 - Frost protection - Set system to run at minimum temperature
 - Error status
- 5 Check energy usage report*** *Additional metering hardware is required.



All A++ or Above!!

Outdoor unit	Indoor unit	For medium-temperature application								For low-temperature application					
		Seasonal space heating energy efficiency class	Water heating energy efficiency class	Rated heat output under average climate conditions	Seasonal space heating energy efficiency under average climate conditions	Water heating energy efficiency under average climate conditions	Sound power level L _{wa} indoor	Sound power level L _{wa} outdoor	Seasonal space heating energy efficiency class	Water heating energy efficiency class	Rated heat output under average climate conditions	Seasonal space heating energy efficiency under average climate conditions	Water heating energy efficiency under average climate conditions	Sound power level L _{wa} indoor	Sound power level L _{wa} outdoor
				kW	%	%					kW	%	%		
SUZ-SWM40VA2(-SC)	EHST17D_****D	A++	A+	5.0	133	147	41	57	A+++	A+	5.0	196	147	41	57
	ERST17D_****D	A++	A+	5.0	135	147	41	57	A+++	A+	5.0	200	147	41	57
	EHST20D_****D	A++	A+	5.0	133	147	41	57	A+++	A+	5.0	196	147	41	57
	ERST20D_****D	A++	A+	5.0	135	147	41	57	A+++	A+	5.0	200	147	41	57
	EHST30D_****D	A++	A+	5.0	133	127	41	57	A+++	A+	5.0	196	127	41	57
	ERST30D_****D	A++	A+	5.0	135	127	41	57	A+++	A+	5.0	200	127	41	57
	EHSD-****D	A++	-	5.0	133	-	41	57	A+++	-	5.0	196	-	41	57
	ERSD-****D	A++	-	5.0	135	-	41	57	A+++	-	5.0	200	-	41	57
SUZ-SHWM40VAH(-SC)	EHST17D_****D	A+	A+	5.0	124	139	41	58	A++	A+	5.0	172	139	41	58
	ERST17D_****D	A++	A+	5.0	126	139	41	58	A+++	A+	5.0	176	139	41	58
	EHST20D_****D	A+	A+	5.0	124	142	41	58	A++	A+	5.0	172	142	41	58
	ERST20D_****D	A++	A+	5.0	126	142	41	58	A+++	A+	5.0	176	142	41	58
	EHST30D_****D	A+	A+	5.0	124	125	41	58	A++	A+	5.0	172	125	41	58
	ERST30D_****D	A++	A+	5.0	126	125	41	58	A+++	A+	5.0	176	125	41	58
	EHSD-****D	A+	-	5.0	124	-	41	58	A++	-	5.0	172	-	41	58
	ERSD-****D	A++	-	5.0	126	-	41	58	A+++	-	5.0	176	-	41	58
SUZ-SWM60VA2(-SC)	EHST17D_****D	A++	A+	6.0	134	139	41	60	A+++	A+	6.0	185	139	41	60
	ERST17D_****D	A++	A+	6.0	136	139	41	60	A+++	A+	6.0	189	139	41	60
	EHST20D_****D	A++	A+	6.0	134	142	41	60	A+++	A+	6.0	185	142	41	60
	ERST20D_****D	A++	A+	6.0	136	142	41	60	A+++	A+	6.0	189	142	41	60
	EHST30D_****D	A++	A+	6.0	134	125	41	60	A+++	A+	6.0	185	125	41	60
	ERST30D_****D	A++	A+	6.0	136	125	41	60	A+++	A+	6.0	189	125	41	60
	EHSD-****D	A++	-	6.0	134	-	41	60	A+++	-	6.0	185	-	41	60
	ERSD-****D	A++	-	6.0	136	-	41	60	A+++	-	6.0	189	-	41	60
SUZ-SHWM60VAH(-SC)	EHST17D_****D	A++	A+	6.0	126	140	41	60	A+++	A+	6.0	175	140	41	60
	ERST17D_****D	A++	A+	6.0	128	140	41	60	A+++	A+	6.0	178	140	41	60
	EHST20D_****D	A++	A+	6.0	126	142	41	60	A+++	A+	6.0	175	142	41	60
	ERST20D_****D	A++	A+	6.0	128	142	41	60	A+++	A+	6.0	178	142	41	60
	EHST30D_****D	A++	A+	6.0	126	139	41	60	A+++	A+	6.0	175	139	41	60
	ERST30D_****D	A++	A+	6.0	128	139	41	60	A+++	A+	6.0	178	139	41	60
	EHSD-****D	A++	-	6.0	126	-	41	60	A+++	-	6.0	175	-	41	60
	ERSD-****D	A++	-	6.0	128	-	41	60	A+++	-	6.0	178	-	41	60
SUZ-SWM80VA2	EHST17D_****D	A++	A+	7.0	133	140	41	60	A+++	A+	7.0	183	140	41	60
	ERST17D_****D	A++	A+	7.0	135	140	41	60	A+++	A+	7.0	187	140	41	60
	EHST20D_****D	A++	A+	7.0	133	142	41	60	A+++	A+	7.0	183	142	41	60
	ERST20D_****D	A++	A+	7.0	135	142	41	60	A+++	A+	7.0	187	142	41	60
	EHST30D_****D	A++	A+	7.0	133	139	41	60	A+++	A+	7.0	183	139	41	60
	ERST30D_****D	A++	A+	7.0	135	139	41	60	A+++	A+	7.0	187	139	41	60
	EHSD-****D	A++	-	7.0	133	-	41	60	A+++	-	7.0	183	-	41	60
	ERSD-****D	A++	-	7.0	135	-	41	60	A+++	-	7.0	187	-	41	60

Note: E**T17/20*.****D use "Load profile L"
E**T30*.****D use "Load profile XL"

Outdoor unit	Indoor unit	For medium-temperature application							For low-temperature application						
		Seasonal space heating energy efficiency class	Water heating energy efficiency class	Rated heat output under average climate conditions	Seasonal space heating energy efficiency under average climate conditions	Water heating energy efficiency under average climate conditions	Sound power level Lwa indoor	Sound power level Lwa outdoor	Seasonal space heating energy efficiency class	Water heating energy efficiency class	Rated heat output under average climate conditions	Seasonal space heating energy efficiency under average climate conditions	Water heating energy efficiency under average climate conditions	Sound power level Lwa indoor	Sound power level Lwa outdoor
				kW	%	%	dB	dB			kW	%	%	dB	dB
SUZ-SWM80VAH2	EHST17D_****D	A++	A+	7.0	128	140	41	60	A+++	A+	7.0	175	140	41	60
	ERST17D_****D	A++	A+	7.0	130	140	41	60	A+++	A+	7.0	178	140	41	60
	EHST20D_****D	A++	A+	7.0	128	142	41	60	A+++	A+	7.0	175	142	41	60
	ERST20D_****D	A++	A+	7.0	130	142	41	60	A+++	A+	7.0	178	142	41	60
	EHST30D_****D	A++	A+	7.0	128	139	41	60	A+++	A+	7.0	175	139	41	60
	ERST30D_****D	A++	A+	7.0	130	139	41	60	A+++	A+	7.0	178	139	41	60
	EHSD-****D	A++	-	7.0	128	-	41	60	A+++	-	7.0	175	-	41	60
	ERSD-****D	A++	-	7.0	130	-	41	60	A+++	-	7.0	178	-	41	60
SUZ-SWM100VA	EHST17D_****D	A++	A+	8.0	133	140	41	62	A+++	A+	8.0	179	140	41	62
	ERST17D_****D	A++	A+	8.0	134	140	41	62	A+++	A+	8.0	182	140	41	62
	EHST20D_****D	A++	A+	8.0	133	142	41	62	A+++	A+	8.0	179	142	41	62
	ERST20D_****D	A++	A+	8.0	134	142	41	62	A+++	A+	8.0	182	142	41	62
	EHST30D_****D	A++	A+	8.0	133	139	41	62	A+++	A+	8.0	179	139	41	62
	ERST30D_****D	A++	A+	8.0	134	139	41	62	A+++	A+	8.0	182	139	41	62
	EHSD-****D	A++	-	8.0	133	-	41	62	A+++	-	8.0	179	-	41	62
	ERSD-****D	A++	-	8.0	134	-	41	62	A+++	-	8.0	182	-	41	62
SUZ-SWM100VAH	EHST17D_****D	A++	A+	8.0	127	140	41	62	A++	A+	8.0	174	140	41	62
	ERST17D_****D	A++	A+	8.0	129	140	41	62	A+++	A+	8.0	177	140	41	62
	EHST20D_****D	A++	A+	8.0	127	142	41	62	A++	A+	8.0	174	142	41	62
	ERST20D_****D	A++	A+	8.0	129	142	41	62	A+++	A+	8.0	177	142	41	62
	EHST30D_****D	A++	A+	8.0	127	139	41	62	A++	A+	8.0	174	139	41	62
	ERST30D_****D	A++	A+	8.0	129	139	41	62	A+++	A+	8.0	177	139	41	62
	EHSD-****D	A++	-	8.0	127	-	41	62	A++	-	8.0	174	-	41	62
	ERSD-****D	A++	-	8.0	129	-	41	62	A+++	-	8.0	177	-	41	62
PUZ-SWM80VAA	ERST20F_****E	A++	A+	8	130	137	41	54	A+++	A+	8	184	137	41	54
	ERST30F_****E	A++	A+	8	130	125	41	54	A+++	A+	8	184	125	41	54
	ERSF-****E	A++	-	8	130	-	41	54	A+++	-	8	184	-	41	54
PUZ-SWM80YAA	ERST20F_****E	A++	A+	8	130	137	41	54	A+++	A+	8	184	137	41	54
	ERST30F_****E	A++	A+	8	130	125	41	54	A+++	A+	8	184	125	41	54
	ERSF-****E	A++	-	8	130	-	41	54	A+++	-	8	184	-	41	54
PUZ-SWM100VAA	ERST20F_****E	A++	A+	10	134	137	41	58	A+++	A+	10	181	137	41	58
	ERST30F_****E	A++	A+	10	134	125	41	58	A+++	A+	10	181	125	41	58
	ERSF-****E	A++	-	10	134	-	41	58	A+++	-	10	181	-	41	58
PUZ-SWM100YAA	ERST20F_****E	A++	A+	10	134	137	41	58	A+++	A+	10	180	137	41	58
	ERST30F_****E	A++	A+	10	134	125	41	58	A+++	A+	10	180	125	41	58
	ERSF-****E	A++	-	10	134	-	41	58	A+++	-	10	180	-	41	58
PUZ-SWM120VAA	ERST20F_****E	A++	A+	12	133	137	41	58	A+++	A+	12	179	137	41	58
	ERST30F_****E	A++	A+	12	133	125	41	58	A+++	A+	12	179	125	41	58
	ERSF-****E	A++	-	12	133	-	41	58	A+++	-	12	179	-	41	58
PUZ-SWM120YAA	ERST20F_****E	A++	A+	12	132	137	41	58	A+++	A+	12	179	137	41	58
	ERST30F_****E	A++	A+	12	132	125	41	58	A+++	A+	12	179	125	41	58
	ERSF-****E	A++	-	12	132	-	41	58	A+++	-	12	179	-	41	58
PUZ-SWM140VAA	ERST20F_****E	A++	A+	14	136	131	41	58	A+++	A+	14	178	131	41	58
	ERST30F_****E	A++	A	14	136	112	41	58	A+++	A	14	178	112	41	58
	ERSF-****E	A++	-	14	136	-	41	58	A+++	-	14	178	-	41	58
PUZ-SWM140YAA	ERST20F_****E	A++	A+	14	135	131	41	58	A+++	A+	14	177	131	41	58
	ERST30F_****E	A++	A	14	135	112	41	58	A+++	A	14	177	112	41	58
	ERSF-****E	A++	-	14	135	-	41	58	A+++	-	14	177	-	41	58

All A++ or Above!!

Outdoor unit	Indoor unit	For medium-temperature application							For low-temperature application						
		Seasonal space heating energy efficiency class	Water heating energy efficiency class	Rated heat output under average climate conditions	Seasonal space heating energy efficiency under average climate conditions	Water heating energy efficiency under average climate conditions	Sound power level L _{wa} indoor	Sound power level L _{wa} outdoor	Seasonal space heating energy efficiency class	Water heating energy efficiency class	Rated heat output under average climate conditions	Seasonal space heating energy efficiency under average climate conditions	Water heating energy efficiency under average climate conditions	Sound power level L _{wa} indoor	Sound power level L _{wa} outdoor
				kW	%	%					kW	%	%		
PUZ-SHWM80VAA	ERST20F-****E	A++	A+	8	134	137	41	54	A+++	A+	8	188	137	41	54
	ERST30F-****E	A++	A+	8	134	125	41	54	A+++	A+	8	188	125	41	54
	ERSF-****E	A++	-	8	134	-	41	54	A+++	-	8	188	-	41	54
PUZ-SHWM80YAA	ERST20F-****E	A++	A+	8	133	137	41	54	A+++	A+	8	187	137	41	54
	ERST30F-****E	A++	A+	8	133	125	41	54	A+++	A+	8	187	125	41	54
	ERSF-****E	A++	-	8	133	-	41	54	A+++	-	8	187	-	41	54
PUZ-SHWM100VAA	ERST20F-****E	A++	A+	10	138	137	41	58	A+++	A+	10	186	137	41	58
	ERST30F-****E	A++	A+	10	138	125	41	58	A+++	A+	10	186	125	41	58
	ERSF-****E	A++	-	10	138	-	41	58	A+++	-	10	186	-	41	58
PUZ-SHWM100YAA	ERST20F-****E	A++	A+	10	138	137	41	58	A+++	A+	10	186	137	41	58
	ERST30F-****E	A++	A+	10	138	125	41	58	A+++	A+	10	186	125	41	58
	ERSF-****E	A++	-	10	138	-	41	58	A+++	-	10	186	-	41	58
PUZ-SHWM120VAA	ERST20F-****E	A++	A+	12	138	137	41	58	A+++	A+	12	182	137	41	58
	ERST30F-****E	A++	A+	12	138	125	41	58	A+++	A+	12	182	125	41	58
	ERSF-****E	A++	-	12	138	-	41	58	A+++	-	12	182	-	41	58
PUZ-SHWM120YAA	ERST20F-****E	A++	A+	12	138	137	41	58	A+++	A+	12	182	137	41	58
	ERST30F-****E	A++	A+	12	138	125	41	58	A+++	A+	12	182	125	41	58
	ERSF-****E	A++	-	12	138	-	41	58	A+++	-	12	182	-	41	58
PUZ-SHWM140VAA	ERST20F-****E	A++	A+	14	142	131	41	58	A+++	A+	14	185	131	41	58
	ERST30F-****E	A++	A	14	142	112	41	58	A+++	A	14	185	112	41	58
	ERSF-****E	A++	-	14	142	-	41	58	A+++	-	14	185	-	41	58
PUZ-SHWM140YAA	ERST20F-****E	A++	A+	14	142	131	41	58	A+++	A+	14	185	131	41	58
	ERST30F-****E	A++	A	14	142	112	41	58	A+++	A	14	185	112	41	58
	ERSF-****E	A++	-	14	142	-	41	58	A+++	-	14	185	-	41	58
PUD-SWM80V/YAA(-BS)	E*ST17D-****D	A++	A+	8.0	131/130	136	41	56	A+++	A+	8.0	178/176	136	41	56
	E*ST20D-****D	A++	A+	8.0	131/130	141	41	56	A+++	A+	8.0	178/176	141	41	56
	E*ST30D-****D	A++	A	8.0	131/130	121	41	56	A+++	A	8.0	178/176	121	41	56
	E*SD-****D	A++	-	8.0	131/130	-	41	56	A+++	-	8.0	178/176	-	41	56
PUD-SWM100V/YAA(-BS)	E*ST20D-****D	A++	A+	10.0	131/130	141	41	59	A+++	A+	10.0	178/177	141	41	59
	E*ST30D-****D	A++	A	10.0	131/130	121	41	59	A+++	A	10.0	178/177	121	41	59
	E*SD-****D	A++	-	10.0	131/130	-	41	59	A+++	-	10.0	178/177	-	41	59
	E*SD-****D	A++	-	10.0	131/130	-	41	59	A+++	-	10.0	178/177	-	41	59
PUD-SWM120V/YAA(-BS)	E*ST20D-****D	A++	A+	12.0	129/128	141	41	60	A+++	A+	12.0	177/176	141	41	60
	E*ST30D-****D	A++	A	12.0	129/128	121	41	60	A+++	A	12.0	177/176	121	41	60
	E*SD-****D	A++	-	12.0	129/128	-	41	60	A+++	-	12.0	177/176	-	41	60
	E*SD-****D	A++	-	12.0	129/128	-	41	60	A+++	-	12.0	177/176	-	41	60

Note: E**T17/20*-****D use "Load profile L"
E**T30*-****D use "Load profile XL"

Outdoor unit	Indoor unit	For medium-temperature application							For low-temperature application						
		Seasonal space heating energy efficiency class	Water heating energy efficiency class	Rated heat output under average climate conditions	Seasonal space heating energy efficiency under average climate conditions	Water heating energy efficiency under average climate conditions	Sound power level L _{WA} indoor	Sound power level L _{WA} outdoor	Seasonal space heating energy efficiency class	Water heating energy efficiency class	Rated heat output under average climate conditions	Seasonal space heating energy efficiency under average climate conditions	Water heating energy efficiency under average climate conditions	Sound power level L _{WA} indoor	Sound power level L _{WA} outdoor
				kW	%	%	dB	dB			kW	%	%	dB	dB
PUD-SHWM80V/YAA(-BS)	E*ST17D-***D	A++	A+	8.0	135/134	136	41	56	A+++	A+	8.0	181/179	136	41	56
	E*ST20D-***D	A++	A+	8.0	135/134	141	41	56	A+++	A+	8.0	181/179	141	41	56
	E*ST30D-***D	A++	A	8.0	135/134	121	41	56	A+++	A	8.0	181/179	121	41	56
	E*SD-***D	A++	-	8.0	135/134	-	41	56	A+++	-	8.0	181/179	-	41	56
PUD-SHWM100V/YAA(-BS)	E*ST20D-***D	A++	A+	10.0	136/135	141	41	59	A+++	A+	10.0	180/178	141	41	59
	E*ST30D-***D	A++	A	10.0	136/135	121	41	59	A+++	A	10.0	180/178	121	41	59
	E*SD-***D	A++	-	10.0	136/135	-	41	59	A+++	-	10.0	180/178	-	41	59
PUD-SHWM120V/YAA(-BS)	E*ST20D-***D	A++	A+	12.0	135/134	141	41	60	A+++	A+	12.0	179/177	141	41	60
	E*ST30D-***D	A++	A	12.0	135/134	121	41	60	A+++	A	12.0	179/177	121	41	60
	E*SD-***D	A++	-	12.0	135/134	-	41	60	A+++	-	12.0	179/177	-	41	60
PUD-SHWM140V/YAA(-BS)	E*ST20D-***D	A++	A+	14.0	134/134	136	41	62	A+++	A+	14.0	179/177	136	41	62
	E*ST30D-***D	A++	A	14.0	134/134	121	41	62	A+++	A	14.0	179/177	121	41	62
	E*SD-***D	A++	-	14.0	134/134	-	41	62	A+++	-	14.0	179/177	-	41	62
PUHZ-SW160YKA(-BS)	EHSE-***D	A++	-	13.5	125	-	45	78	A++	-	15.3	151	-	45	78
	ERSE-***D	A++	-	13.5	126	-	45	78	A++	-	15.3	152	-	45	78
PUHZ-SW200YKA(-BS)	EHSE-***D	A++	-	15.5	127	-	45	78	A++	-	17.3	147	-	45	78
	ERSE-***D	A++	-	15.5	129	-	45	78	A++	-	17.3	148	-	45	78
PUHZ-SHW230YKA2	EHSE-***D	A++	-	23.0	127	-	45	75	A++	-	25.0	164	-	45	75
	ERSE-***D	A++	-	23.0	128	-	45	75	A++	-	25.0	165	-	45	75
PUZ-WM50VHA(-BS)	EHPT17X-***D(W)	A++	A+	5.0	129	120	40	61	A+++	A+	5.0	183	120	40	61
	ERPT17X-***D(W)	A++	A+	5.0	133	120	40	61	A+++	A+	5.0	190	120	40	61
	EHPT20X-***D(W)	A++	A+	5.0	129	135	40	61	A+++	A+	5.0	183	135	40	61
	ERPT20X-***D(W)	A++	A+	5.0	133	135	40	61	A+++	A+	5.0	190	135	40	61
	EHPX-***D	A++	-	5.0	129	-	40	61	A+++	-	5.0	183	-	40	61
	ERPX-***D	A++	-	5.0	133	-	40	61	A+++	-	5.0	190	-	40	61
PUZ-WM60VAA(-BS)	EHPT17X-***D(W)	A++	A+	6.0	142	120	40	58	A+++	A+	6.0	190	120	40	58
	ERPT17X-***D(W)	A++	A+	6.0	145	120	40	58	A+++	A+	6.0	197	120	40	58
	EHPT20X-***D(W)	A++	A+	6.0	142	141	40	58	A+++	A+	6.0	190	141	40	58
	ERPT20X-***D(W)	A++	A+	6.0	145	141	40	58	A+++	A+	6.0	197	141	40	58
	EHPX-***D	A++	-	6.0	142	-	40	58	A+++	-	6.0	190	-	40	58
	ERPX-***D	A++	-	6.0	145	-	40	58	A+++	-	6.0	197	-	40	58

Note: E**T17/20*-***D use "Load profile L"
E**T30*-***D use "Load profile XL"

All A++ or Above!!

Outdoor unit	Indoor unit	For medium-temperature application							For low-temperature application						
		Seasonal space heating energy efficiency class	Water heating energy efficiency class	Rated heat output under average climate conditions	Seasonal space heating energy efficiency under average climate conditions	Water heating energy efficiency under average climate conditions	Sound power level L _{wa} indoor	Sound power level L _{wa} outdoor	Seasonal space heating energy efficiency class	Water heating energy efficiency class	Rated heat output under average climate conditions	Seasonal space heating energy efficiency under average climate conditions	Water heating energy efficiency under average climate conditions	Sound power level L _{wa} indoor	Sound power level L _{wa} outdoor
				kW	%	%	dB	dB			kW	%	%	dB	dB
PUZ-WM85V/YAA(-BS)	EHPT17X-***D(W)	A++	A+	8.5	139/138	120	40	58	A+++	A+	8.5	193/190	120	40	58
	ERPT17X-***D(W)	A++	A+	8.5	141/141	120	40	58	A+++	A+	8.5	197/197	120	40	58
	EHPT20X-***D(W)	A++	A+	8.5	139/138	141	40	58	A+++	A+	8.5	193/190	141	40	58
	ERPT20X-***D(W)	A++	A+	8.5	141/141	141	40	58	A+++	A+	8.5	197/197	141	40	58
	EHPT30X-***D(W)	A++	A	8.5	139/138	120	40	58	A+++	A	8.5	193/190	120	40	58
	ERPT30X-***D(W)	A++	A	8.5	141/141	120	40	58	A+++	A	8.5	197/197	120	40	58
	EHPX-***D	A++	-	8.5	139/138	-	40	58	A+++	-	8.5	193/190	-	40	58
	ERPX-***D	A++	-	8.5	141/141	-	40	58	A+++	-	8.5	197/197	-	40	58
PUZ-WM112V/YAA(-BS)	EHPT20X-***D(W)	A++	A+	10.0	134/133	138	40	60	A+++	A+	10.0	191/189	138	40	60
	ERPT20X-***D(W)	A++	A+	10.0	136/136	138	40	60	A+++	A+	10.0	195/195	138	40	60
	EHPT30X-***D(W)	A++	A	10.0	134/133	120	40	60	A+++	A	10.0	191/189	120	40	60
	ERPT30X-***D(W)	A++	A	10.0	136/136	120	40	60	A+++	A	10.0	195/195	120	40	60
	EHPX-***D	A++	-	10.0	134/133	-	40	60	A+++	-	10.0	191/189	-	40	60
	ERPX-***D	A++	-	10.0	136/136	-	40	60	A+++	-	10.0	195/195	-	40	60
PUZ-HWM140V/YHA(-BS)	EHPT20X-***D(W)	A++	A+	14.0	132/131	124	40	67	A+++	A+	14.0	176/175	124	40	67
	ERPT20X-***D(W)	A++	A+	14.0	133/133	124	40	67	A+++	A+	14.0	178/177	124	40	67
	EHPT30X-***D(W)	A++	A	14.0	132/131	112	40	67	A+++	A	14.0	176/175	112	40	67
	ERPT30X-***D(W)	A++	A	14.0	133/133	112	40	67	A+++	A	14.0	178/177	112	40	67
	EHPX-***D	A++	-	14.0	132/131	-	40	67	A+++	-	14.0	176/175	-	40	67
	ERPX-***D	A++	-	14.0	133/133	-	40	67	A+++	-	14.0	178/177	-	40	67
PUHZ-FRP71VHA2	EHST20C-***D	A+	A+	7.5	121	138	40	68	A++	A+	7.5	163	138	40	68
	EHSC-***D	A+	-	7.5	121	-	40	68	A++	-	7.5	163	-	40	68
PUMY-P112VKM6/YKM5(-BS)	EHST20C-***D	A+	A	11.2	121/121	106	40	69	A++	A	11.2	168/168	106	40	69
	EHSC-***D	A+	-	11.2	121/121	-	40	69	A++	-	11.2	168/168	-	40	69
PUMY-P125VKM6/YKM5(-BS)	EHST20C-***D	A+	A	11.2	121/121	106	40	69	A++	A	11.2	168/168	106	40	69
	EHSC-***D	A+	-	11.2	121/121	-	40	69	A++	-	11.2	168/168	-	40	69
PUMY-P140VKM6/YKM5(-BS)	EHST20C-***D	A+	A	11.2	121/121	106	40	69	A++	A	11.2	168/168	106	40	69
	EHSC-***D	A+	-	11.2	121/121	-	40	69	A++	-	11.2	168/168	-	40	69
PXZ-4F75VG	EHST17D-****D	A+	A+	6.0	113	117	41	67	A++	A+	6.0	154	117	41	67
	ERST17D-****D	A+	A+	6.0	113	117	41	67	A++	A+	6.0	154	117	41	67
	EHST20D-****D	A+	A+	6.0	113	124	41	67	A++	A+	6.0	154	124	41	67
	ERST20D-****D	A+	A+	6.0	113	124	41	67	A++	A+	6.0	154	124	41	67
	EHST30D-****D	A+	A	6.0	113	118	41	67	A++	A	6.0	154	118	41	67
	ERST30D-****D	A+	A	6.0	113	118	41	67	A++	A	6.0	154	118	41	67
	EHSD-****D	A+	-	6.0	113	-	41	67	A++	-	6.0	154	-	41	67
	ERSD-****D	A+	-	6.0	113	-	41	67	A++	-	6.0	154	-	41	67
PXZ-5F85VG	EHST17D-****D	A+	A+	7.0	111	121	41	64	A++	A+	7.0	157	121	41	64
	ERST17D-****D	A+	A+	7.0	111	121	41	64	A++	A+	7.0	157	121	41	64
	EHST20D-****D	A+	A+	7.0	111	123	41	64	A++	A+	7.0	157	123	41	64
	ERST20D-****D	A+	A+	7.0	111	123	41	64	A++	A+	7.0	157	123	41	64
	EHST30D-****D	A+	A	7.0	111	110	41	64	A++	A	7.0	157	110	41	64
	ERST30D-****D	A+	A	7.0	111	110	41	64	A++	A	7.0	157	110	41	64
	EHSD-****D	A+	-	7.0	111	-	41	64	A++	-	7.0	157	-	41	64
	ERSD-****D	A+	-	7.0	111	-	41	64	A++	-	7.0	157	-	41	64

Note: E**T17/20*-***D use "Load profile L"
E**T30*-***D use "Load profile XL"



Refrigerant Amount

	Model Name	Refrigerant		Pre-charged quantity	
			GWP	Weight (kg)	CO ₂ equivalent (t)
PUMY	PUMY-P112VKM5(-BS)	R410A	2088	4.8	10.02
	PUMY-P125VKM5(-BS)	R410A	2088	4.8	10.02
	PUMY-P140VKM5(-BS)	R410A	2088	4.8	10.02
ATW Packaged	PUZ-WM50VHA	R32	675	2	1.35
	PUZ-WM85V/YAA	R32	675	2.2	1.49
	PUZ-WM112V/YAA	R32	675	3	2.03
	PUZ-HWM140V/YHA	R32	675	3.3	2.23
ATW Split	SUZ-SWM40VA2	R32	675	0.8	0.54
	SUZ-SWM60VA2	R32	675	0.8	0.54
	SUZ-SWM80VA2	R32	675	1.1	0.74
	SUZ-SWM100VA	R32	675	1.1	0.74
	PUD-SWM80V/YAA	R32	675	1.3	0.88
	PUD-SWM100V/YAA	R32	675	1.6	1.08
	PUD-SWM120V/YAA	R32	675	1.6	1.08
	PUD-SHWM80V/YAA	R32	675	1.4	0.95
	PUD-SHWM100V/YAA	R32	675	1.7	1.15
	PUD-SHWM120V/YAA	R32	675	1.7	1.15
	PUD-SHWM140V/YAA	R32	675	1.7	1.15
	PUHZ-SW160YKA	R410A	2088	7.1	14.82
	PUHZ-SW200YKA	R410A	2088	7.7	16.08
	PUHZ-SHW230YKA2	R410A	2088	7.1	14.82
	PUZ-SWM80VAA	R32	675	1.8	1.22
	PUZ-SWM100V/YAA	R32	675	1.8	1.22
	PUZ-SWM120V/YAA	R32	675	1.8	1.22
	PUZ-SWM140V/YAA	R32	675	1.8	1.22
	PUZ-SHWM80V/YAA	R32	675	1.8	1.22
	PUZ-SHWM100V/YAA	R32	675	1.8	1.22
	PUZ-SHWM120V/YAA	R32	675	1.8	1.22
	PUZ-SHWM140V/YAA	R32	675	1.8	1.22
	Multi Comfort	PXZ-4F75VG	R32	675	2.4
PXZ-5F85VG		R32	675	2.4	1.62
Mr. Slim+	PUHZ-FRP71VHA2	R410A	2088	3.8	7.94



 **NOTICE**

Our air-conditioning equipments and heat pumps contain a fluorinated greenhouse gas, R410A (GWP: 2088) or R32 (GWP: 675). *These GWP values are based on Regulation (EU) No.517/2014 from IPCC 4th edition. In case of Regulation (EU) No.626/2011 from IPCC 3rd edition, these are as follows. R410A (GWP: 1975), R32 (GWP: 550)

 **CAUTION**

Do not install indoor units in areas (e.g. mobile phone base stations) where the emission of VOCs such as phthalate compounds and formaldehyde is known to be high as this may result in a chemical reaction.

 **WARNING**

When installing or relocating or servicing our air-conditioning equipment, use only the specified refrigerant (R410A or R32) to charge the refrigerant lines.

Do not mix it with any other refrigerant and do not allow air to remain in the lines.

If air is mixed with the refrigerant, then it can be the cause of abnormal high pressure in the refrigerant lines, and may result in an explosion and other hazards.

The use of any refrigerant other than that specified for the system will cause mechanical failure, system malfunction or unit breakdown. In the worst case, this could lead to a serious impediment to securing product safety.

MITSUBISHI ELECTRIC CORPORATION

HEAD OFFICE: TOKYO BUILDING, 2-7-3 MARUNOUCHI, CHIYODA-KU, TOKYO 100-8310, JAPAN
<https://www.mitsubishielectric.com/>

Full Product Catalogue - Heating 2024 (Air to Water)
E-2407260(18726)

